

TACOSSETTER BYPASS SOLAR 185

BALANCING VALVE



Direct regulation, indication and isolation of flows in solar systems.

DESCRIPTION

Direct hydraulic balancing and control of flows to consumers or in a subsystem. Balancing valves offer an easy and accurate method of adjusting the flow rates for heating-, ventilation-, air conditioning - and solar systems.

The Version TacoSetter Bypass Solar 185 is designed for higher operating temperatures.

Correct balancing of hydraulic circuits ensures optimum energy distribution, resulting in more efficient and economical operation in accordance with the energy saving regulations provided for by legislation.

With TacoSetter Bypass Solar 185 balancing valves, any qualified fitter can set the appropriate flow rate using the unique flow measurement device, avoiding investments in training and costly measuring devices.

INSTALLATION POSITION

The TacoSetter Bypass Solar 185 requires a straight section of pipe of the same length and diameter as the system. The valve can be installed in a horizontal, vertical or inclined position. Care should be taken that the arrow is pointing in the direction of the flow.

ADVANTAGES

- Accurate and fast adjustment with scale and without the aid of diagrams, tables or measurement devices
- Direct reading of the set volume flow in l/min
- Temperature-resistant up to 185 °C
- Variable installation position, maintenance-free
- Flow control with setpoint adjuster
- Regulating valve with isolating facility (rest leakage possible)
- Minimal pressure loss

In the case of the high-temperature type, the bypass unit is replaced by the sealing cap set after adjustment.

OPERATION

The flow measurement is based on the principle of a baffle float with return spring. The reading position is the bottom line of the baffle float. The measuring device is placed in a bypass to the main flow, isolated from system flow. By demand the bypass, with self locking valves, gets opened / closed by pressing / releasing the clamp. Reading the flow rate has no influence on the main flow rate.

BUILDING CATEGORIES

For pipe installations in heating and cooling area:

- Apartment blocks, housing estates, multiple dwelling units
- Residential care facilities and hospitals
- Administration and service buildings
- Hotels and restaurants, industrial kitchens
- School buildings and sports facilities
- Commercial and industrial buildings
- Facilities with partial use, such as barracks, camping sites

SYSTEM/BASIC DIAGRAM

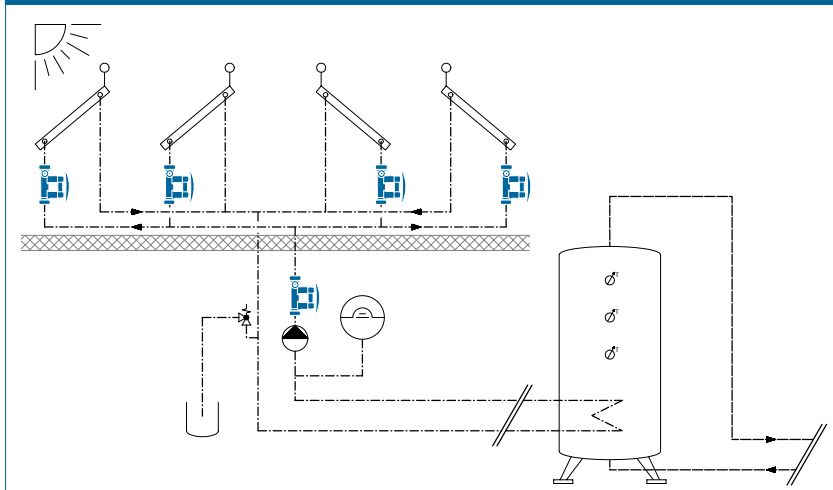

TACOSSETTER BYPASS SOLAR 185 | BALANCING VALVE

SPECIFICATION TEXT

See www.taconova.com

TECHNICAL DATA

General

- Admissible operating parameters
 $T_{0\text{ max}}$ und $P_{0\text{ max}}$: see pressure temperature curve
- Measuring accuracy:
 - Measurement range <25%:
 $\pm 20\%$ of the indicated value
 - Measurement range >25%:
 $\pm 10\%$ of the indicated value
- k_{VS} value and measurement range: see "Type Program"
- Female thread to DIN 2999 / ISO 7 or male thread G (cylindrical) to ISO 228

Material

- Housing: brass
- Inside: stainless steel, brass, plastic
- Sight glass: heat- and impact-resistant plastic
- Sealing: EPDM

Fluids

- Heating water (VDI 2035; SWKI BT 102-01; ÖNORM H 5195-1)
- Potable water (DIN 1988-200)
- Water and proprietary additives used against corrosion and freezing up to 50% (see document «Correction curves»)

ADDITIONAL MODELS

Balancing valves for solar applications, see TacoSetter Bypass 100 and TacoSetter Bypass Solar 130 data sheets.

TYPE OVERVIEW

TacoSetter Bypass Solar 185 | Balancing valve with female thread (incl. sealing cap set)

Order no.	DN	Rp × Rp	Measuring range	k_{VS} (m ³ /h)
223.2382.000	20	¾" × ¾"	2 – 12 (l/min)	2,2
223.2383.000	20	¾" × ¾"	8 – 30 (l/min)	5,0
223.2480.000	25	1" × 1"	10 – 40 (l/min)	8,1
223.2580.000	32	1¼" × 1¼"	20 – 70 (l/min)	17,0

TacoSetter Bypass Solar 185 | Balancing valve with male thread (incl. sealing cap set)

Order no.	DN	G × G	Measuring range	k_{VS} (m ³ /h)
223.2382.385	20	1" × 1"	2 – 12 (l/min)	2,2
223.2383.385	20	1" × 1"	8 – 30 (l/min)	5,0

DIMENSIONAL DRAWING

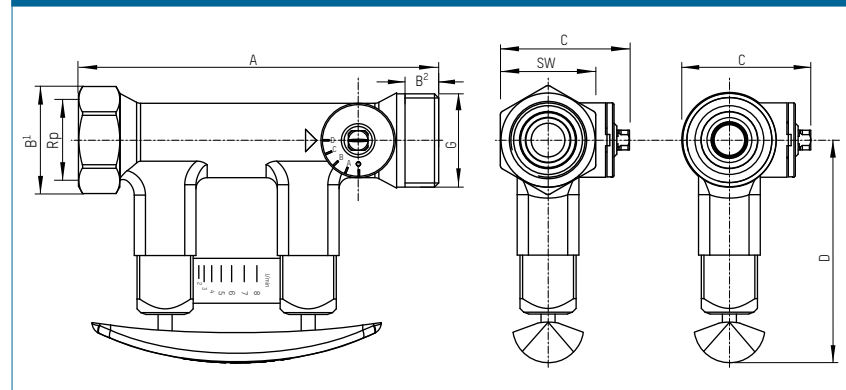

MEASUREMENT TABLE

TacoSetter Bypass Solar 185 | Balancing valve with female thread

Order no.	DN	A	B ¹	C	D	SW	Rp
223.2382.000	20	129	39	46	79	34	¾"
223.2383.000	20	129	39	46	79	34	¾"
223.2480.000	25	152	47	58	82	41	1"
223.2580.000	32	161	56	65	84	49	1"

TacoSetter Bypass Solar 185 | Balancing valve with male thread

Order no.	DN	A	B ²	C	D	G
223.2382.385	20	129	12	46	79	1"
223.2383.385	20	129	12	46	79	1"

GLYCOL CORRECTION CURVES

There is a separate diagram for TacoSetter up to DN25 and its flow ranges with nine correction curves for use of anti-frost and anti-corrosion agents.

Corrections are not required for larger dimensions as the deviation lies within the measuring tolerance.

See www.taconova.com

TACOSSETTER BYPASS SOLAR 185 | BALANCING VALVE

PRESSURE - TEMPERATURE-CHARACTERISTIC

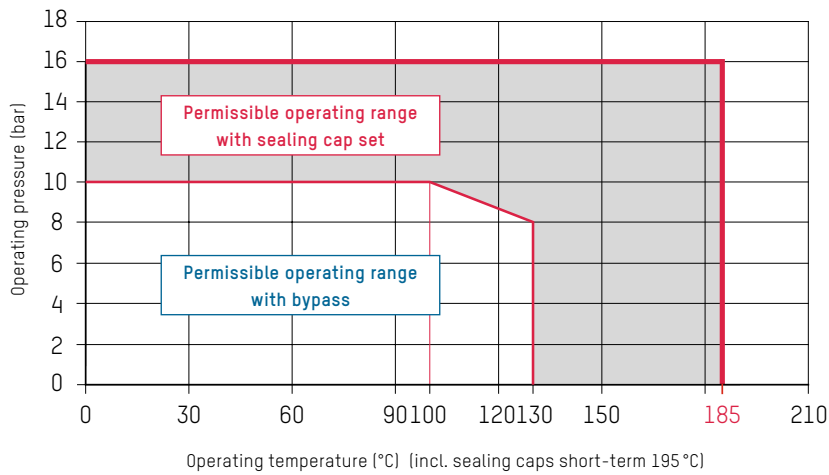

PRESSURE LOSS DIAGRAMS

223.2382.XXX (DN 20 | ½" | 2...12 l/min)

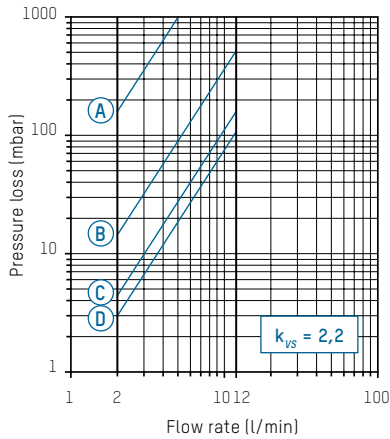

A - D Valve position

223.2383.XXX (DN 20 | ½" | 8...30 l/min)

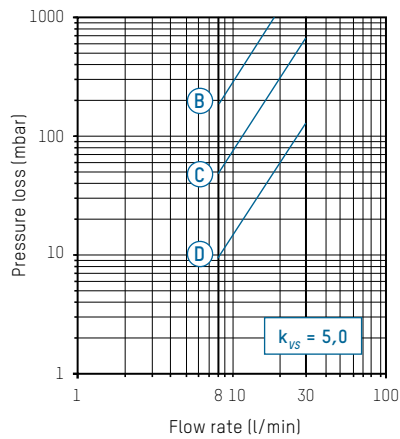

B - D Valve position

223.2480.XXX (DN 25 | 1" | 10...40 l/min)

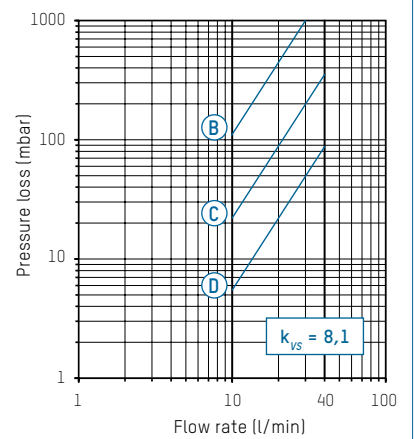

B - D Valve position

223.2580.000 (DN 32 | 1¼" | 20...70 l/min)

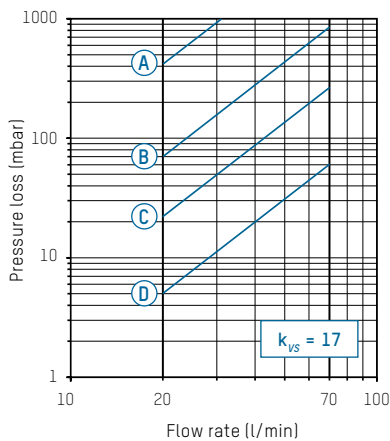

A - D Valve position

TACOSSETTER BYPASS SOLAR 185 | BALANCING VALVE

ACCESSORIES



SYSTEM SCREW CONNECTION FITS TO TACOSSETTER BYPASS

Screw connection with male thread R (conical) as per DIN 2999

Order no.	G x R	Version for	Fits to
210.6630.000	3/4" x 1/2"	Threaded pipe Rp 1/2"	DN 15
210.6631.000	1" x 1/2"	Threaded pipe Rp 1/2"	DN 15
210.6632.000	1" x 3/4"	Threaded pipe Rp 3/4"	DN 20
210.6633.000	1 1/4" x 1"	Threaded pipe Rp 1"	DN 25



Screw connection with solder connection

Order no.	G x mm	Version for	Fits to
210.5331.019	1" x 18	Copper pipe ø 18 mm	DN 15 AG
210.5332.019	1" x 22	Copper pipe ø 22 mm	DN 20 AG
210.5334.003	1 1/4" x 28	Copper pipe ø 28 mm	DN 25 AG

SPARE PARTS



SIGHT GLASS (COMPLETE) AND SEAL

Order no.	Range	Fits to
298.2336.020	2 – 12 (l/min)	223.2380.000 / 223.2380.350
298.2337.020	8 – 20 (l/min)	223.2381.000 / 223.2381.350
298.2338.020	8 – 30 (l/min)	223.2383.000 / 223.2383.385
298.2344.020	10 – 40 (l/min)	223.2482.000 / 223.2482.350



SEALING CAP SET FOR TACOSSETTER BYPASS 130/185

Order no.	Fits to
296.2340.003	all versions

Included with delivery for Solar 185 model