

# TACOTHERM FRESH MEGA2 (C/CL)

FRESH HOT WATER STATION WITH HIGH-EFFICIENCY PUMPS

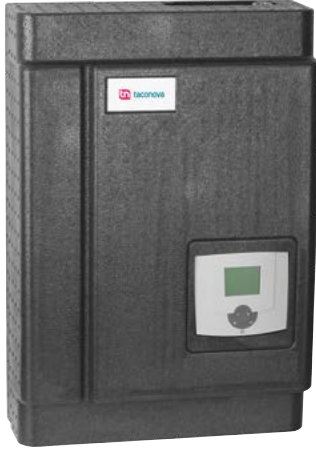

## ADVANTAGES

### Compact and versatile

- Models: with and without circulation pump, dual-zone return stratification
- Cascading possible

### Secure

- Integration in building control system via optionally available ModBus RTU interface
- Integrated safety subassembly and soft-close valves

### Simple

- Valves and components are fully preassembled as well as fully wired ready for connection

### Efficient

- Simple and fast commissioning

Fresh hot water station for hygienically heating drinking water in accordance with the continuous flow principle with innovative regulation technology

## DESCRIPTION

The TacoTherm Fresh Mega2 (C/CL) fresh water station is used for on-demand preparation of domestic hot water in accordance with the continuous flow principle. It retrieves the heat from the storage tank of an existing or new heating system, which uses solid-fuel boilers, heat pumps, solar systems, etc. as a heat source. The station replaces the storage of hot drinking water and thus provides a high degree of protection against Legionella by avoiding water stagnation.

## INSTALLATION POSITION

Vertical wall-mounting in the vicinity of the hot water storage tank or on the tank itself.

## OPERATION

Drinking water is heated to the defined dispensing temperature in the TacoTherm Fresh Mega2 (C/CL) in accordance with the continuous flow principle. The integrated heat exchanger is supplied with as little hot water from the storage tank as is required to maintain a constant dispensing temperature.

The latest pump and regulation technology is used. In recording the temperature difference and flow rate data, the electronic regulator simultaneously records and stores the quantity of heat consumed. In addition to an additional circulation pump that can be installed, the TacoTherm Fresh Mega2 (C/CL) can also be supplied with a switching valve for dual-zone return stratification. The primary pump, circulation pump as well as load valve are controlled by the integrated regulator in accordance with specifications.

## BUILDING CATEGORIES

- Apartment blocks
- Housing estates
- Multiple dwelling units
- Smaller public buildings
- Facilities with partial use – for example barracks, camping sites, etc.

## SYSTEM/BASIC DIAGRAM

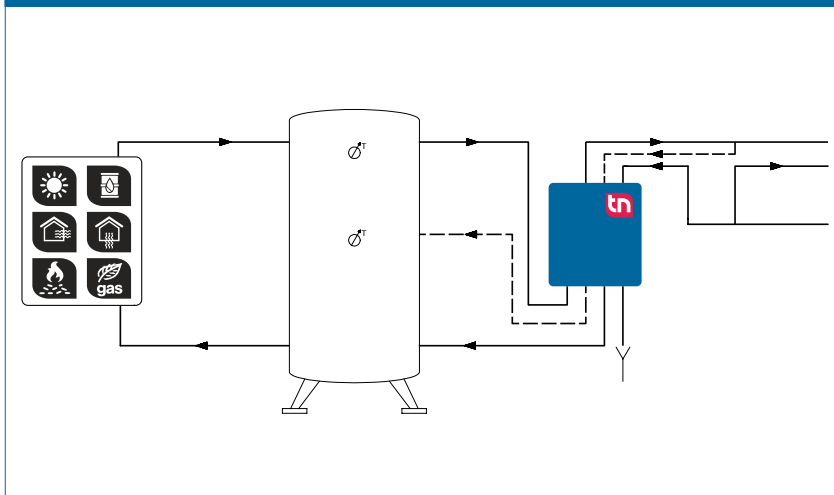

# TACOTHERM FRESH MEGA2 | FRESH HOT WATER STATION

## SPECIFICATION TEXT

See [www.taconova.com](http://www.taconova.com)

## TECHNICAL DATA

### General

- TacoTherm Fresh Mega2 controller
- Weight (empty): 17.5 – 20 kg
- Overall dimensions (incl. hood):  
W 470 mm × H 685 mm × D 193 mm

### Material

- Base plate: Galvanized sheet steel
- Rear panel and hood: EPP design insulation
- Pumps:
  - Primary: Cast steel
  - Secondary: PPS (plastic, approved for drinking water)
- Valve housing: Brass
- Pipes: DN 20 stainless steel 1.4404
- Plate heat exchanger:
  - Plates and connector pieces: Stainless steel 1.4401
  - Heat exchanger solder: 99.99 % copper (stainless steel solder model available on request)
- Seals: AFM flush seal

### Primary side

- Operating temperature  $T_{0\max}$ : 95 °C
- Operating pressure  $P_{0\max}$ : 10 bar
- Primary pump: Grundfos UPM3 Hybrid 15-70

### Secondary side

Modules on secondary side with drinking water certifications

- Operating temperature  $T_{0\max}$ : 85 °C
- Operating pressure  $P_{0\max}$ : 9 bar
- Safety valve (intrinsic safety): 10 bar discharge pressure and 9 bar closing pressure
- Circulation pump: Grundfos UPM3 Auto L 15-70

### Performance data

- See design diagram

### Electrical connection data

- Mains voltage: 230 VAC ± 10 %
- Mains frequency: 50...60 Hz
- Power consumption: max. 250 W
- Protection type: IP 40

### Flow media

- Heating water (VDI 2035; SWKI BT 102-01; ÖNORM H 5195-1)
- Cold water

## TYPE OVERVIEW

### TacoTherm Fresh Mega2 | Fresh hot water station

Order no.	Rp	Version	Version
272.6025.000	1" IT / ¾" IT		Without circulating pump, without dual-zone return stratification
273.6625.000	1" IT / ¾" IT	C	With circulating pump, without dual-zone return stratification
273.6620.000	1" IT / ¾" IT	CL	With circulating pump and dual-zone return stratification

## DIMENSIONAL DRAWING

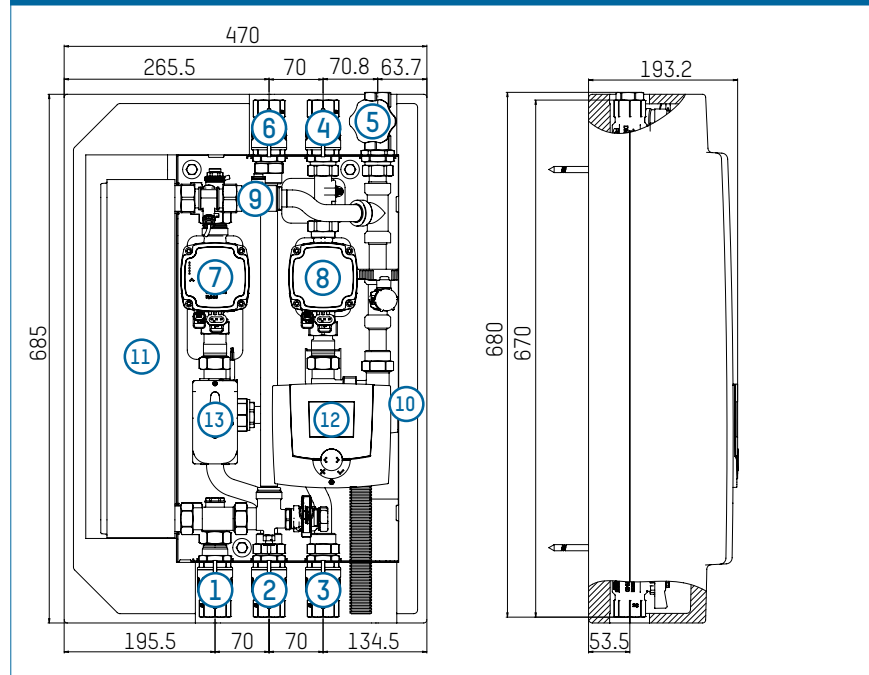

## PRODUCT DIAGRAM

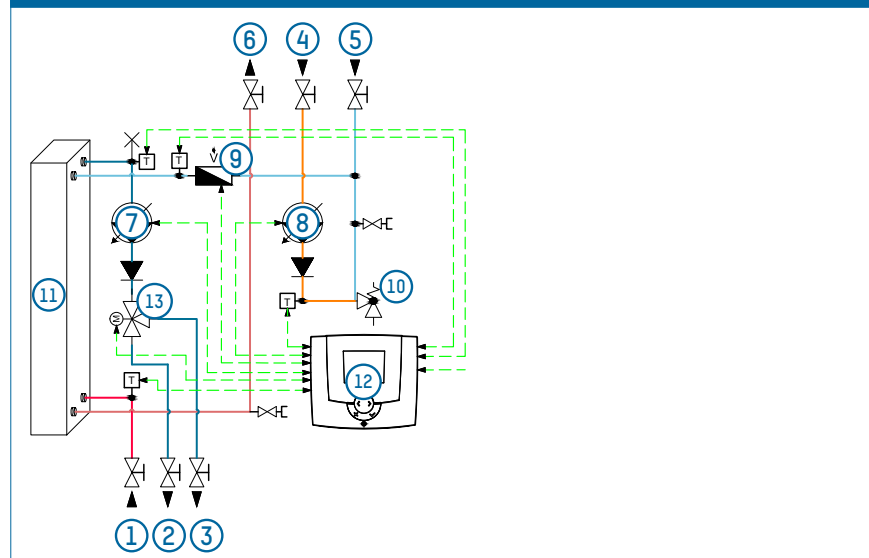

- |   |                                   |
|---|-----------------------------------|
| 1 Primary hot water flow  | 7 Primary pump                    |
| 2 Primary hot water return 1 (integration of storage tank in center in CL models) | 8 Circulation pump (C/CL version) |
| 3 Primary hot water return 2 (integration of storage tank below)                  | 9 Flow rate sensor                |
| 4 Circulation (C/CL version)  | 10 Safety valve                   |
| 5 Cold water connection (¾")  | 11 Heat exchanger                 |
| 6 Hot water connection  | 12 Regulator                      |
|   | 13 Switching valve (CL version)   |

**FLOW AND PRESSURE LOSS DIAGRAMS  
COLD WATER HEATING AT 50K (10 ... 60 °C)**

**D) Secondary pressure loss**

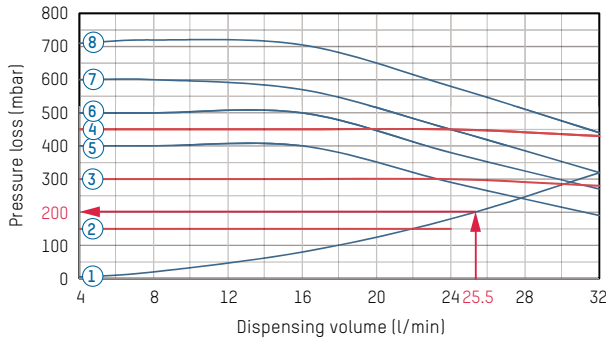

- 1 Pressure loss for cold water and circulation (secondary)
- 2 Circulation pump, constant pressure 1
- 3 Circulation pump, constant pressure 2
- 4 Circulation pump, constant pressure 3
- 5 Circulation pump, constant curve 1
- 6 Circulation pump, constant curve 2
- 7 Circulation pump, constant curve 3
- 8 Circulation pump, constant curve 4

**C) Return temperatures**

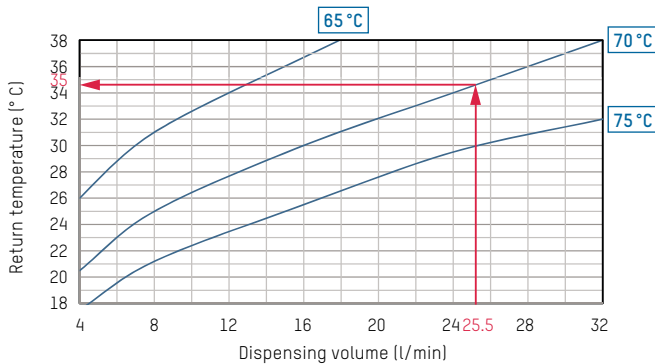

**A) Cold water heating at 50K**

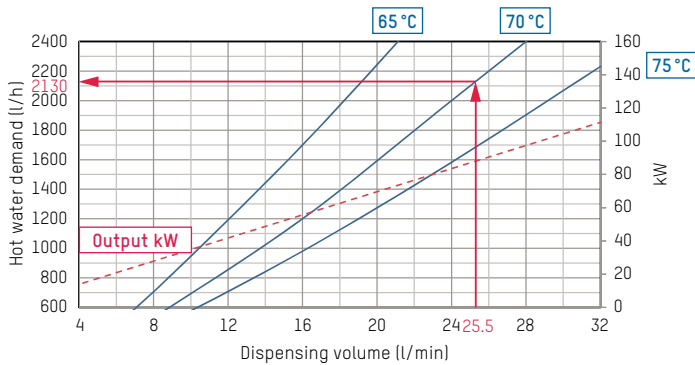

**B) Residual head | Primary pressure loss**

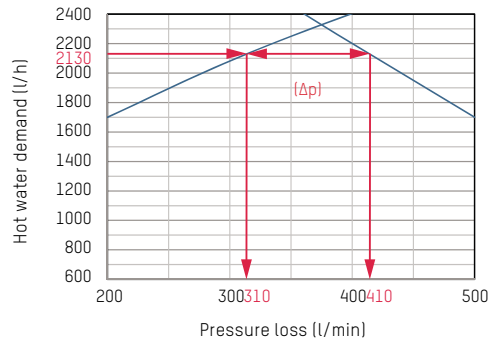

**EXAMPLE FOR INTERPRETING THE FLOW RATE AND PRESSURE LOSS DIAGRAMS**

**Given**

- Hot water dispensing volume: 25.5 l/min
- Primary heating flow temperature: 70 °C

**Sought**

- Hot water demand (l/h)
- Primary heating return temperature in °C
- Secondary pressure loss in mbar
- Primary pressure loss in mbar

**Approach**

- In Diagram A) the hot water demand at the intersection point of the dispensing volume of 25.5 l/min and primary flow temperature of 70 °C is 2130 l/h.
- In Diagram B) the primary pressure loss for a hot water demand of 2130 l/h is 310 mbar. The pump delivery head is 410 mbar, discounting the pressure loss this gives rise to a residual pump head of 100 mbar (Δp).

- In Diagram C) the primary return temperature for a given dispensing volume of 25.5 l/min and the selected flow temperature of 70 °C is 35 °C.
- In Diagram D) the secondary pressure loss for the given data is 200 mbar

**FLOW AND PRESSURE LOSS DIAGRAMS**  
**COLD WATER HEATING AT 35K (10 ... 45 °C)**

**D) Secondary pressure loss**

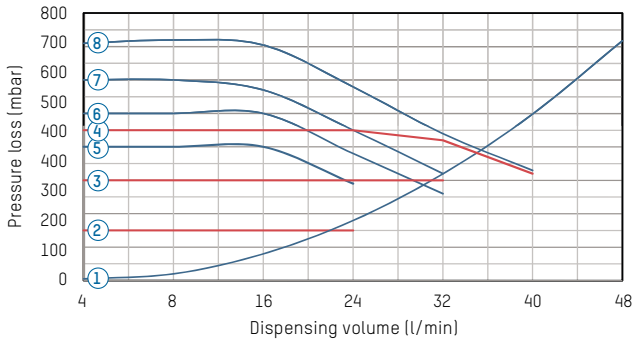

- 1 Pressure loss for cold water and circulation (secondary)
- 2 Circulation pump, constant pressure 1
- 3 Circulation pump, constant pressure 2
- 4 Circulation pump, constant pressure 3
- 5 Circulation pump, constant curve 1
- 6 Circulation pump, constant curve 2
- 7 Circulation pump, constant curve 3
- 8 Circulation pump, constant curve 4

**C) Return temperatures**

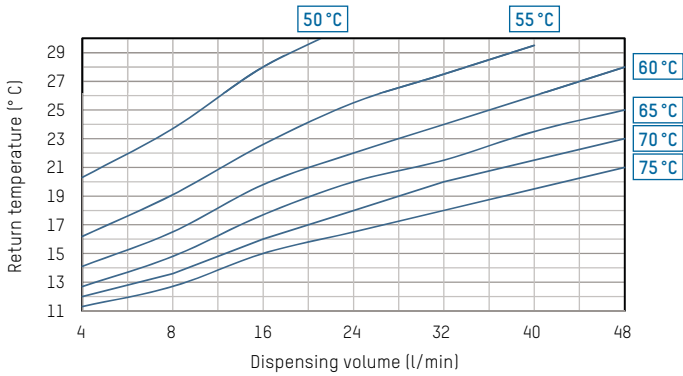

**A) Cold water heating at 35K**

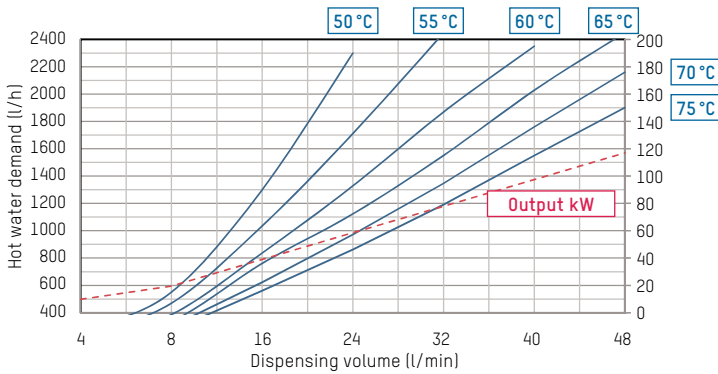

**B) Residual head**

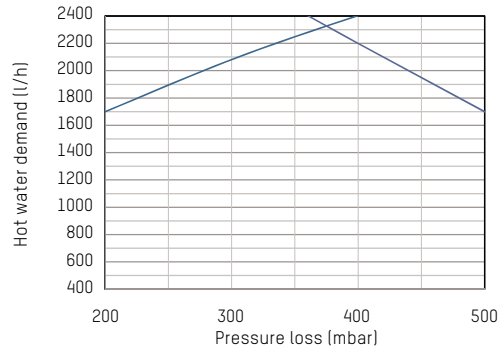

**NOTE**

**REQUIREMENTS FOR FLOW MEDIA**

The stations heat interface units use a copper-soldered stainless steel plate heat exchanger as standard. It must be checked prior to use in the framework of system planning whether the issues of corrosion protection and scale formation have been sufficiently taken into account in accordance with DIN 1988200 and current drinking water analyses according to DIN EN 8065.

See datasheet „Plate Heat Exchanger Requirements - Limit Values for Drinking Water Quality“.

ACCESSORIES

MODBUS RTU INTERFACE

Order no.	Description
296.7027.000	For integration with the building control system

ACCESSORIES FOR CASCADE CIRCUITRY

Order no.	Rp	Description
295.0200.000		Basic construction kit
295.0201.000		Extension kit
296.7036.000		Second zone valve for basic construction kit (sequence switching operation)
296.7024.000	1 ¼"	External storage restratification
296.7025.000	2"	External storage restratification
272.6030.391		External circulation

SAMPLE ORDER FOR CASCADE MODULE

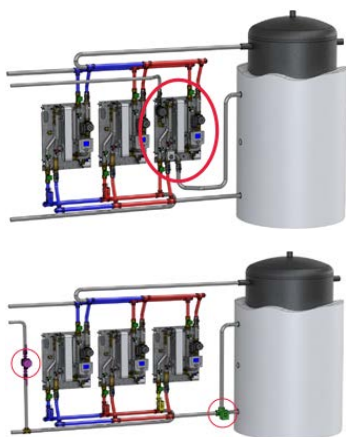

CASCADE CIRCUIT WITH INTEGRATED CIRCULATION AND STORAGE STRATIFICATION, WITHOUT SEQUENCE SWITCHING

Order no.	2-way cascade	3-way cascade	4-way cascade	5-way cascade
272.6025.000	1	2	3	4
273.6620.000	1	1	1	1
295.0200.000	1	1	1*	1*
295.0201.000	0	1	2*	3*

CASCADE CIRCUIT WITH EXTERNAL CIRCULATION, WITH EXTERNAL STORAGE STRATIFICATION FOR SEQUENCE SWITCHING

Order no.	2-way cascade	3-way cascade	4-way cascade	5-way cascade
272.6025.000	2	3	4	5
295.0200.000	1	1	1*	1*
295.0201.000	0	1	2*	3*
296.7036.000	1	1	1	1
296.7024.000	1*	0	0	0
296.7025.000	0	1	1	1
272.6030.391	1	1	1	1

\* Attention: Note pressure losses in the cascade pipe sets and diverting valves.