

FX 96 RESOL Solar controller

DeltaSol® BS and DeltaSol® BS Pro

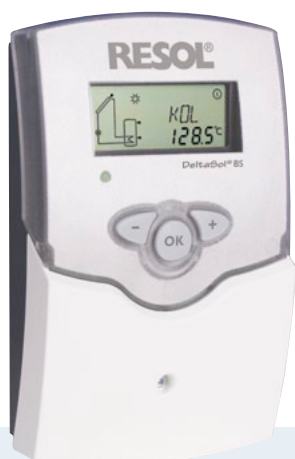

RESOL DeltaSol® BS

Solar controller for application in simple solar systems

Description

Illuminated system-monitoring-display with 2 application schemes stored, pictograms, a 4-digit alphanumerical 16-segment- and a 4-digit numerical 7-segment-display for indication of temperatures as well as control- and adjustment parameters.

Pushbuttons for precise operation and modification of settings. Adjustable options just as cooling function, collector safety shutdown, tube collector special function, heat quantity balancing, anti-freeze function, thermostat function, language switching English/German/French/Italian.

Function control according to BAW-guidelines.

Equipment:

Plug-in plastic housing, 173×110×47 mm, 2-digit LC system-monitoring-display with illuminated background, 1 control lamp (2-coloured), 4 temperature sensor inputs Pt1000, 2 standard relay outputs, manual operation by software, VBus connection (additional thermostat function for after-heating, application 2), 1 × accessory bag DeltaSol® BS

RESOL DeltaSol® BS Plus

Solar controller for application in 1-store-, 2-store- and east-/west collector-solar systems as well as for control of 2 separate T-circuits

Description

Same as DeltaSol® BS, however with 9 application schemes stored, pictograms and speed control.

Equipment:

Plug-in plastic housing, 173×110×47 mm, 2-digit LC system-monitoring-display with illuminated background, 1 control lamp (2-coloured), 4 temperature sensor inputs Pt1000, 2 semi-conductor relay outputs, manual operation by software, VBus connection (additional thermostat function for after-heating, application 3), 1 × accessory bag DeltaSol® BS Pro

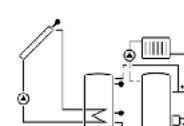
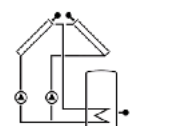
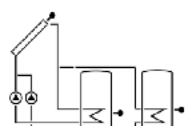
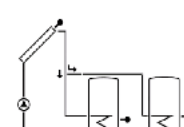
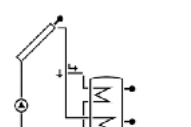
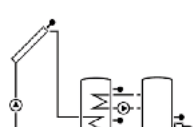
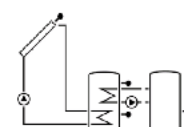
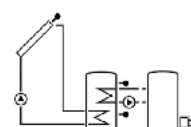
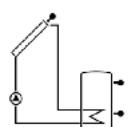
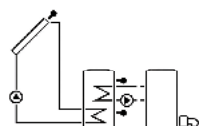
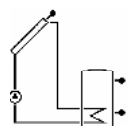

Type Program

RESOL DeltaSol® BS

Code no.

296.7010.000

Scope of supply

Incl. 2 temperature sensors Pt1000
(1 × FKP6 with silicone cable 1.5 m, 1 × FRP6 with PUR-cable 2.5 m),
Instruction manual

RESOL DeltaSol® BS Plus

Code no.

296.7011.000

Scope of supply

Incl. 4 temperature sensors Pt1000
(2 × FKP6 with silicone cable 1.5 m, 2 × FRP6 with PUR-cable 2.5 m),
Instruction manual

Dimensions

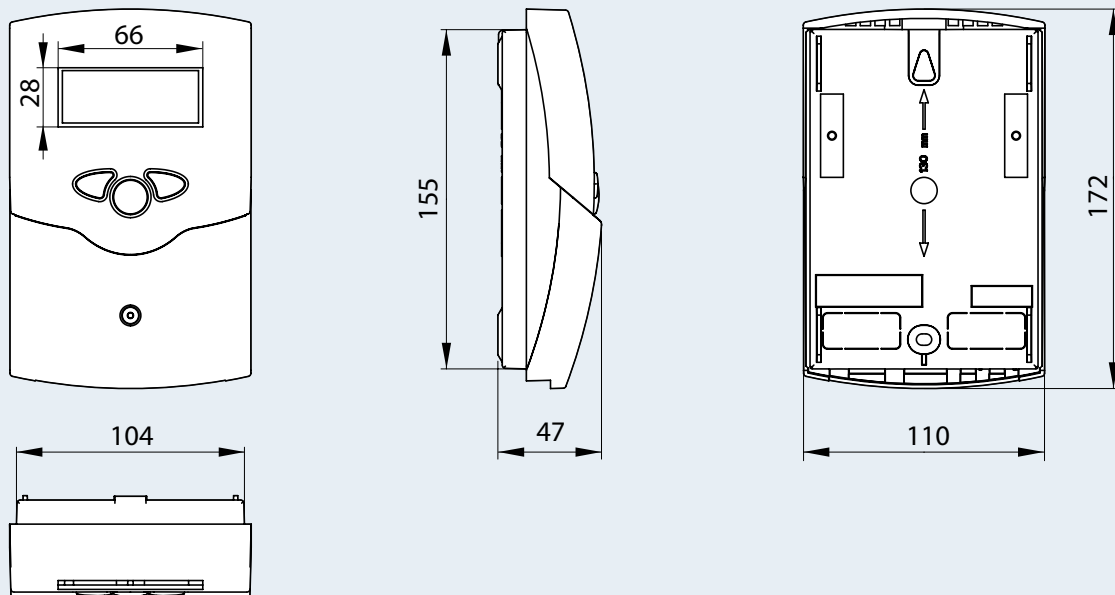

Accessories



Temperature sensor PT1000 with silicone cable 2 m

Code no.

296.7009.000



Sensor pockets for RESOL DeltaSol® BS and RESOL DeltaSol® Pro

TH 45 (immersion depth 45 mm, brass chrome-plated, R ½")

Code no.

296.7008.000

TH 150 (immersion depth 150 mm, copper nickel-plated, R ½")

Code no.

296.7007.000