

# RESOL DeltaSol<sup>®</sup> BS

**Mounting**  
**Connection**  
**Operation**  
**Troubleshooting**  
**Examples**



DeltaSol<sup>®</sup> BS

GB

manual

[www.resol.de](http://www.resol.de)



48000360

**Thank you for buying this RESOL product.**  
**Read this manual carefully to get the best performance from this unit.**

**Safety advice**

Please pay attention to the following safety advice in order to avoid danger and damage to people and property.

**Appropriate usage**

This product is to be used in solar thermal systems in compliance with the technical data specified in these instructions (see p. 3).

Improper use excludes all liability claims

**Instructions:**

Attention should be paid to

- valid local regulations
- the statutory provisions for prevention of industrial accidents,
- the statutory provisions for environmental protection,
- the Health and Safety at Work Act 1974
- Part P of the Building Regulations 2005
- BS7671 Requirements for electrical installations and relevant safety regulations of DIN, EN, DVGW, TRGI, TRF and VDE.

These instructions are exclusively addressed to authorised skilled personnel.

- Only qualified electricians should carry out installation and maintenance work.
- Initial installation should be carried out by named qualified personnel

Subject to change without prior notice. Errors excepted

**Table of contents**

<b>Safety instructions.....</b>	<b>2</b>
<b>Technical data and overview of functions.....</b>	<b>3</b>
<b>1. Installation.....</b>	<b>5</b>
1.1 Mounting.....	5
1.2 Electrical wiring.....	5
1.2.1 Standard solar system.....	6
1.2.2 Solar system and after-heating.....	6
<b>2. Operation and function .....</b>	<b>7</b>
2.1 Buttons for adjustment.....	7
2.2 System monitoring display .....	7
2.2.1 Channel display.....	7
2.2.2 Tool bar.....	7
2.2.3 System screen.....	8
2.3 Flashing codes.....	8
2.3.1 System-Screen flashing codes .....	8
2.3.2 LED flashing codes.....	8
<b>3. Commissioning .....</b>	<b>9</b>
<b>4. Control parameter and display channels .....</b>	<b>10</b>
4.1 Overview.....	10
4.1.1-6 Display channels.....	11
4.1.7-19 Adjustment channels.....	12
<b>5. Troubleshooting.....</b>	<b>17</b>
5.1 Various.....	18
<b>6. Accessory .....</b>	<b>20</b>
<b>Imprint .....</b>	<b>20</b>

**Declaration of conformity**

We, RESOL Elektronische Regelungen GmbH, D-45527 Hattingen, declare under our sole responsibility that our product DeltaSol® BS complies with the following standards:

EN 55 014-1

EN 60 730-1

According to the regulations of the above directives, the product is labelled with **CE**:

89/336/EWG

73/ 23/EWG

Hattingen, 07.07.2006

RESOL Elektronische Regelungen GmbH,

ppa. 

ppa. Gerald Neuse

- system-monitoring display
- up to 4 temperature sensors Pt1000
- heat quantity measurement
- function control
- user-friendly operation through simple handling
- optional pump speed control, solar operating hours counter and thermostat function

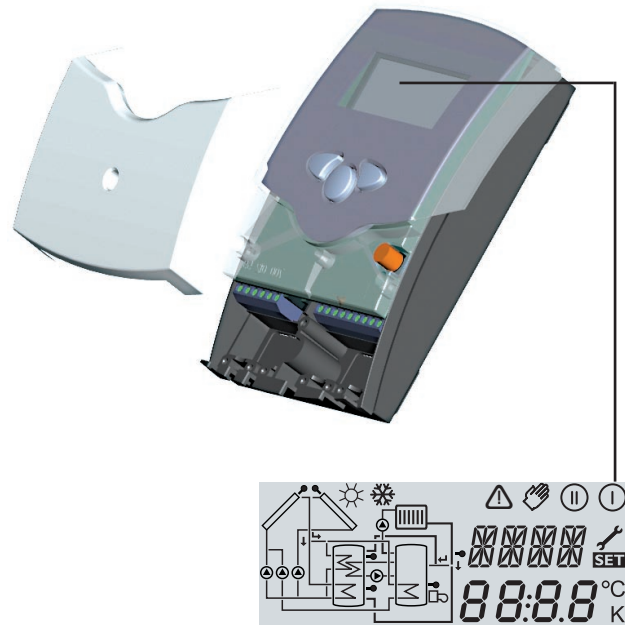

#### Scope of delivery:

1 x DeltaSol® BS

1 x accessory bag

1 x fuse T4A

2 x screws and dowels

4 x strain relief and screws

Additionally enclosed in the full kit:

1 x sensor FKP6

2 x sensor FRP6

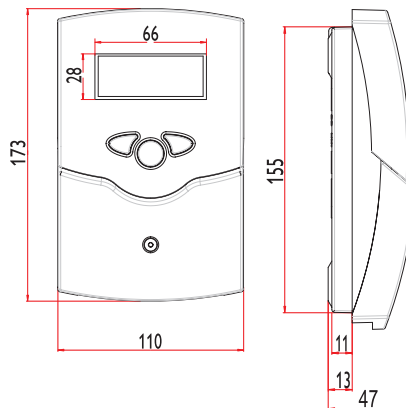

The DeltaSol® BS is a controller for standard solar thermal systems. It provides a clear operating concept and is equipped with a system-monitoring display. Flashing symbols for sensors, pumps and valves show temperatures, temperature differences and active actuators. The DeltaSol® BS controller is available in 4 versions

#### Controller version

Controller version PG	Semiconductor relay	Standard relay	Operating hours counter	Pump speed control	Thermostat function	Heat quantity measurement
66.30	0	1	yes	no	no	yes
67.30	1	0	yes	yes	no	yes
68.30	0	2	yes	no	yes	yes
69.30	1	1	yes	yes	yes	yes

#### Technical data

##### Housing:

plastic, PC-ABS and PMMA

**Protection type:** IP 20 / DIN 40050

**Ambient temp.:** 0 ... 40 °C

**Dimensions:** 172 x 110 x 46 mm

**Mounting:** wall mounting, mounting into patch-panels is possible

**Display:** System screen for systems visualisation, 16-segment display, 7-segment display, 8 symbols for system status and operating control lamp

**Operation:** 3 push buttons at the front of the housing

**Functions:** Differential temperature controller with optional system functions. Function control according to BAW-guidelines, operating hours counter for solar pump, tube collector function, pump speed control (PG 67.30 and PG 69.30) as well as heat quantity measurement.

**Inputs:** for 4 temperature sensors Pt1000

**Outputs:** depending on version, see above

##### Power supply:

220 ... 240 V~

##### Mode of operation:

Type 1.b (version 66.30, 68.30)

Type 1.y (version 67.30, 69.30)

##### Switching capacity:

semiconductor relay:

1 (1) A (220 ... 240) V~

electromechanical relay:

2 (1) A (220 ... 240) V~



**Examples DeltaSol® BS**

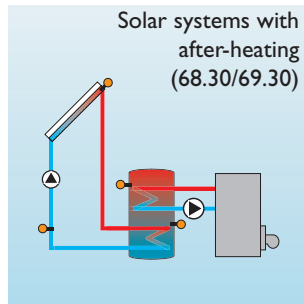
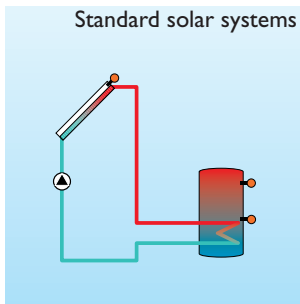

For detailed connection diagrams see chapter 1.



**Order note**

- **Version 66.30: 1 standard relay, operating hours counter**  
**RESOL DeltaSol® BS / 1** **115 410 10**  
**RESOL DeltaSol® BS / 1 - full kit**  
 incl. 3 temperature sensors Pt1000 (1 x FKP6, 2 x FRP6) **115 410 20**
- **Version 67.30: 1 semiconductor relay, speed control, operating hours counter**  
**RESOL DeltaSol® BS / 2** **115 410 30**  
**RESOL DeltaSol® BS / 2 - full kit**  
 incl. 3 temperature sensors Pt1000 (1 x FKP6, 2 x FRP6) **115 410 40**
- **Version 68.30: 2 standard relay, thermostat function, operating hours counter**  
**RESOL DeltaSol® BS / 3** **115 420 60**  
**RESOL DeltaSol® BS / 3 - full kit**  
 incl. 3 temperature sensors Pt1000 (1 x FKP6, 2 x FRP6) **115 410 70**
- **Version 69.30: 1 standard relay, 1 standard relay, speed control, operating hours counter, thermostat function**  
**RESOL DeltaSol® BS / 4** **115 420 80**  
**RESOL DeltaSol® BS / 4 - full kit**  
 incl. 3 temperature sensors Pt1000 (1 x FKP6, 2 x FRP6) **115 420 90**



**Accessory**  
**Overvoltage protection**

It is recommended that the RESOL overvoltage protection SP1 be connected to all collector sensors in order to avoid overvoltages (e.g. by lightning).

**RESOL SP1** Art.-No.: **180 110 10**

# 1. Installation

## 1.1 Mounting

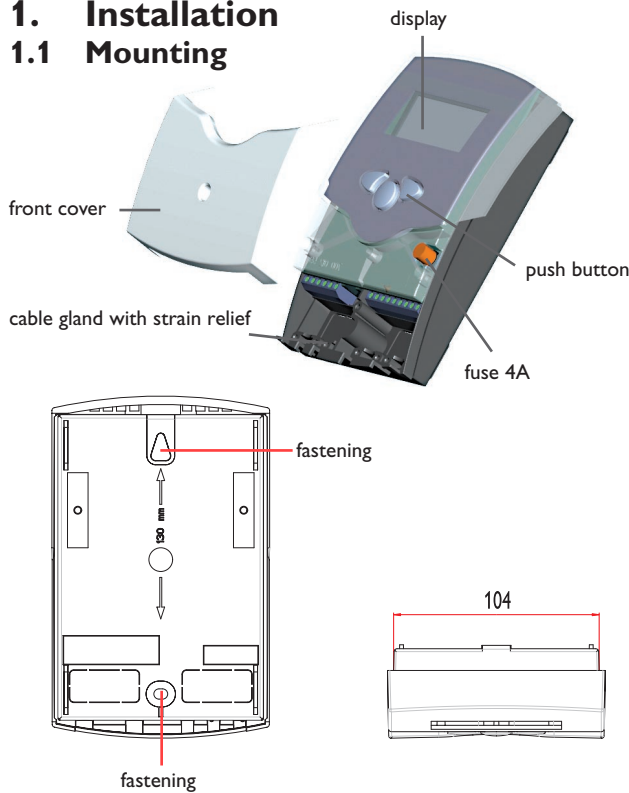

**WARNING!**  
Always switch-off power supply and disconnect the controller from the mains before opening the housing!

The unit must only be located in dry interior locations. It is not suitable for installation in hazardous locations and should not be placed close to any electromagnetic fields. The controller must additionally be supplied from a double-pole switch with contact gap of at least 3 mm. Please pay attention to separate routing of sensor cables and mains cables.

1. Unscrew the cross-head screw from the cover and remove it along with the cover from the housing.
2. Mark the upper fastening point on the wall and drill and fasten the enclosed wall plug and screw leaving the head protruding.
3. Hang the housing from the upper fastening point and mark the lower fastening point through the hole in the terminal box (centres 130 mm). Drill and insert the lower wall plug.
4. Fasten the housing to the wall with lower fastening screw and tighten.

## 1.2 Electrical connection

PG 66.30 and 67.30

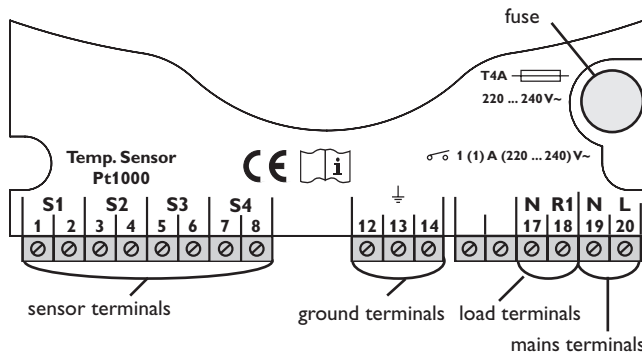

PG 68.30 and 69.30

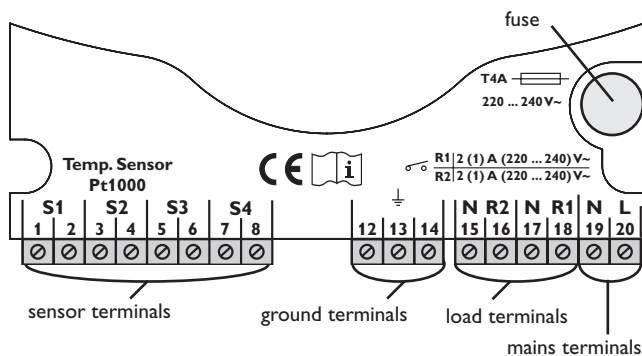

The power supply to the controller must be carried out via an external power switch (last step!) and the supply voltage must be 220 ... 240V~ (50 ... 60 Hz). Flexible cables must be attached to the housing with the enclosed strain relief and the corresponding screws.

Depending on the version, the controller is equipped with either 1 relay (PG 66.30 and PG 67.30) or 2 relays (PG 68.30 and PG 69.30) to which **loads** such as pumps, valves, etc. can be connected:

- Relay 1  
18 = conductor R1  
17 = neutral conductor N  
13 = ground clamp (⊕)
- Relay 2 (PG 68.30 and 69.30)  
16 = conductor R2  
15 = neutral conductor N  
14 = ground clamp (⊕)

**Temperature sensors (S1 to S4)** have to be connected to the following terminals (either polarity):

- 1 / 2 = sensor 1 (e.g. sensor collector 1)
- 3 / 4 = sensor 2 (e.g. sensor store 1)
- 5 / 6 = sensor 3 (e.g. store top sensor)
- 7 / 8 = sensor 4 (e.g. return temperature sensor)

The **power supply connection** has to be carried out via the following terminals:

- 19 = neutral conductor N
- 20 = conductor L
- 12 = ground clamp (⊕)



Electrostatic discharge can lead to damage to electronic components!



Dangerous voltage!

1.2.1 Allocation of terminals for system 1

Standard solar system with 1 store, 1 pump and 3 sensors. The sensor S4 / TR can be optionally used for heat quantity measurement.

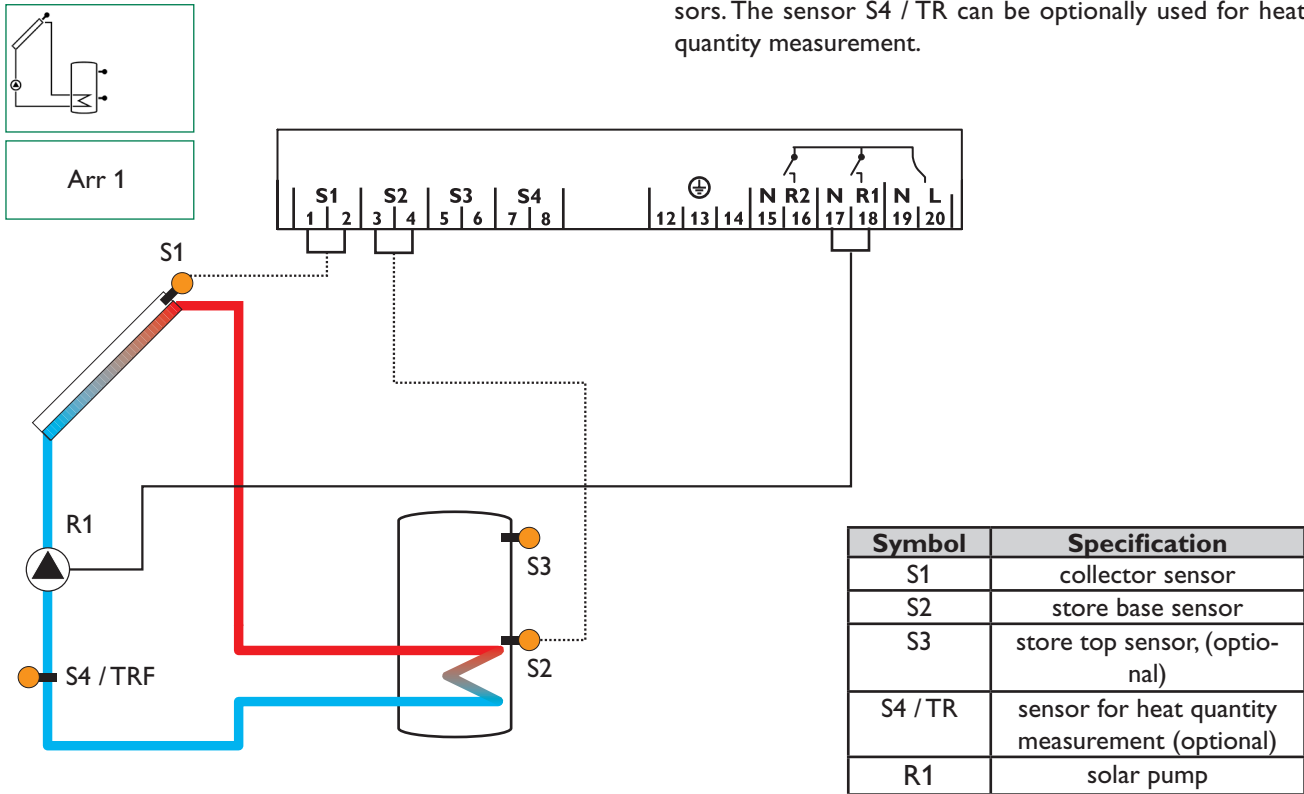

1.2.2 Allocation of terminals for system 2  
(PG 68.30 and PG 69.30)

Solar system and after-heating with 1 store, 3 sensors and after-heating. The sensor S4 / TRF can be optionally used for heat quantity balancing.

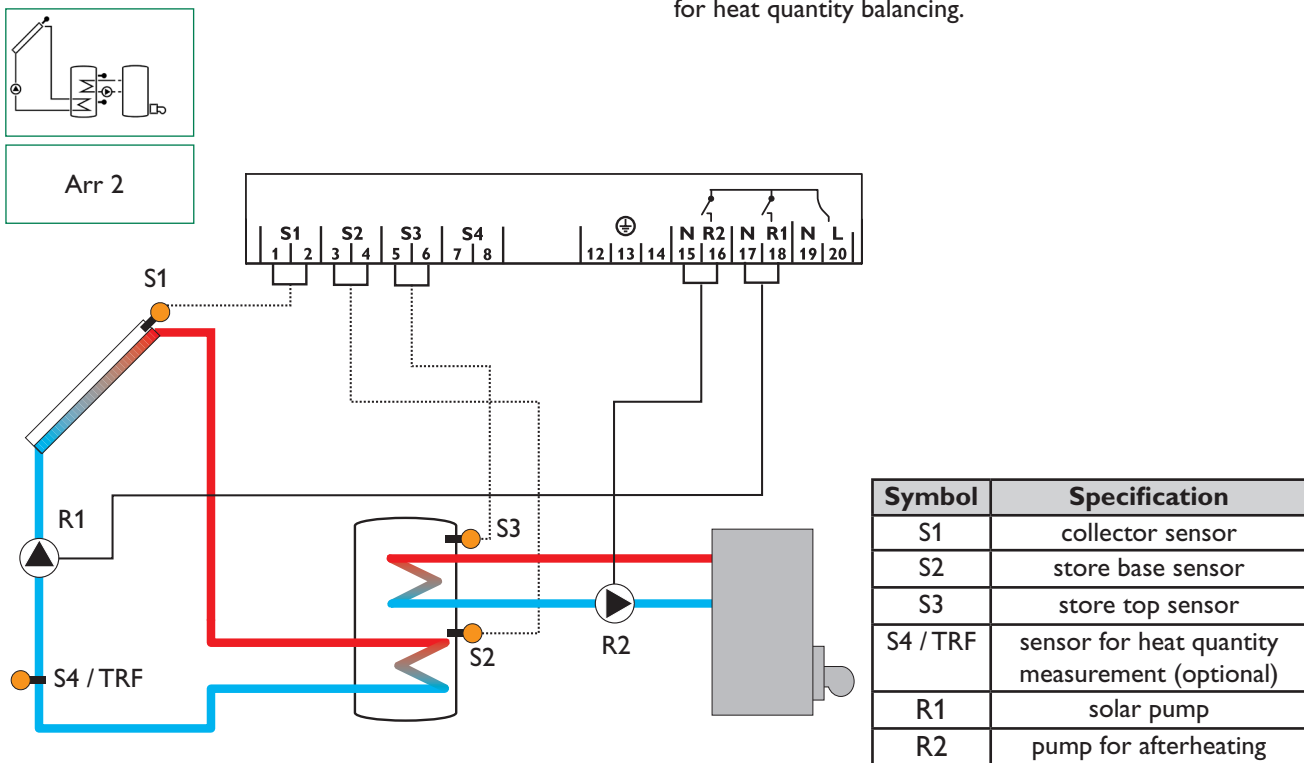

## 2. Operation and function

### 2.1 Buttons for adjustment

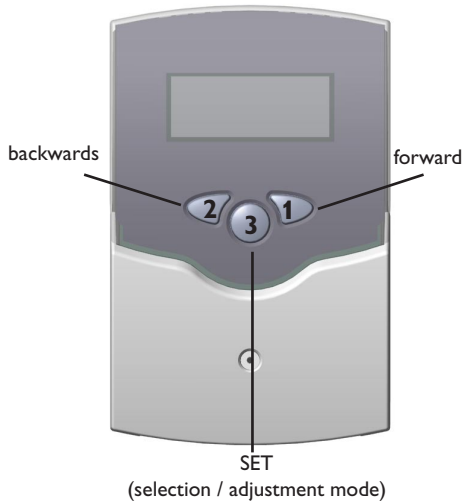

The controller is operated via the 3 push buttons below the display. The forward-button (1) is used for scrolling forward through the display menu or to increase the adjustment values. The backward-button (2) is similarly used for scrolling backwards and reducing values.

In order to access the adjustment mode, scroll down in the display menu and press the forward button (1) for approx. 2 seconds after you have reached the last display item. If an **adjustment value** is shown on the display, the „SEt“ icon is displayed. Now, you can access the adjustment mode by using button 3.

- Press buttons 1 and 2 in order to select a channel
- Briefly press button 3, „SEt“ will flash
- Adjust the value by pressing buttons 1 and 2
- Briefly press buttons 3, so that „SEt“ permanently appears, the adjusted value will be saved.

### 2.2 System monitoring display

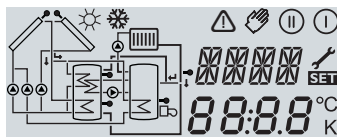

Complete Monitoring-Display

The system monitoring display consists of 3 blocks: **channel display**, **tool bar** and **system screen** (active arrangement).

#### 2.2.1 Channel display



channel display

The **channel display** consists of two lines. The upper line is an alpha-numeric 16-segment display (text display) for displaying channel names and menu items. In the lower 7-segment display, the channel values and the adjustment parameters are displayed.

Temperatures and temperature differences are indicated in °C or K respectively.

#### 2.2.2 Tool bar

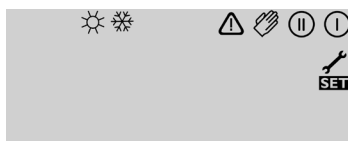

tool bar

The additional symbols in the **tool bar** indicate the actual system status.

Symbol	standard	flashing
ⓘ	relay 1 active	
Ⓜ	relay 2 active	
☀	store maximum limitation active / maximum store temperature exceeded	collector cooling function or recooling function active
❄	antifreeze- function activated	collector minimum limitation or antifreeze function active
⚠		collector emergency shutdown or store emergency shutdown active
⚠ + 🔧		sensor defect
⚠ + 🖐		manual operation active
SEt		SET-mode, change of adjustment value is possible

2.2.3 System screen

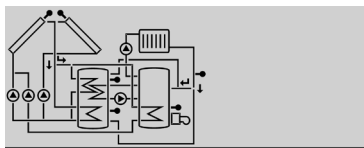

system screen

The system screen (active arrangement) shows the scheme which has been selected. The screen consists of several system component symbols, which are - depending on the current status of the system - either flashing, permanently shown or „hidden“.

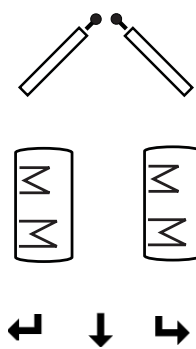
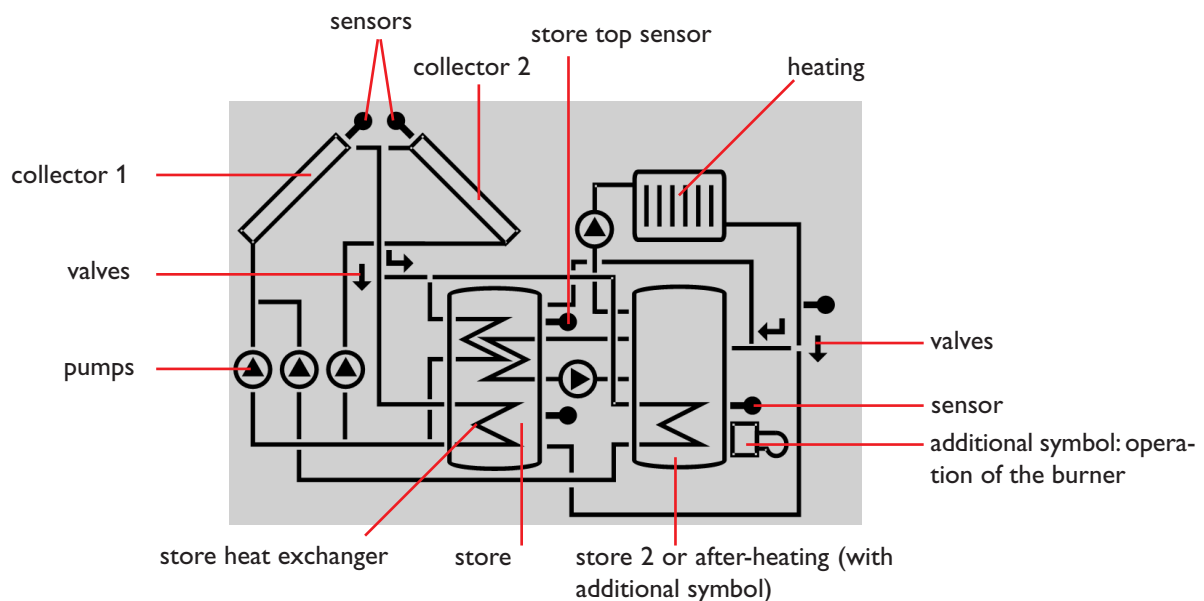

**collectors**  
with collector sensor

**store 1 and 2**  
with heat exchanger

**3-port-valves**  
flow direction or current switch position are indicated.

**temperature sensor**

**heating circuit**

**pump**

**After-heating**  
with burner symbol

2.3 Flashing codes

2.3.1 System screen codes

- Pump symbols are flashing during initialisation phase
- Sensor symbols are flashing if the corresponding sensor display channel is selected.
- Sensor symbols are flashing in the case of a sensor fault.
- Burner symbol is flashing if the after-heating is active

2.3.2 LED flashing codes

- green: everything OK
- red/green flashing: initialisation phase
- red flashing: sensor fault (sensor symbol is flashing quickly)
- manual operation

### 3. Commissioning

When the controller is commissioned for the first time, the arrangement has to be selected first

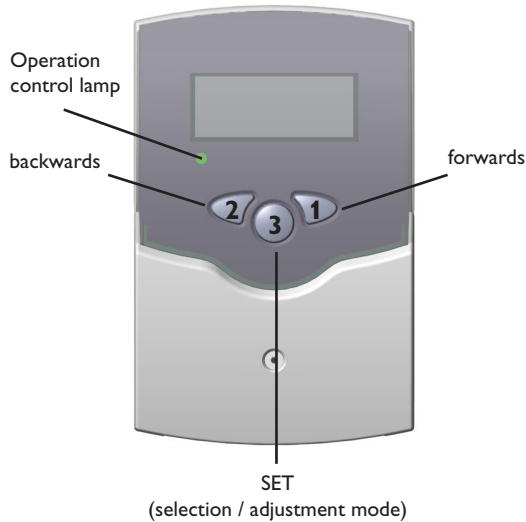

1. Switch on power supply. During the initialisation phase, the operating control lamp flashes red and green. After initialisation, the controller is in the automatic mode with typical settings. The pre-programmed system scheme is Arr 1.

2. - select adjustment channel Arr

- change to the **SET**-mode (see 2.1)
- select the arrangement via the Arr-index number
- save the adjustment by pressing the **SET** button

Now the controller is ready for operation with typical settings to suit that system and normally the factory settings will give close to optimum operation.

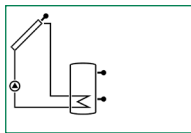

Arr 1

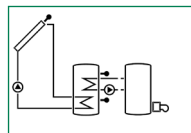

Arr 2

#### Overview of arrangements:

Arr 1 : standard solar system

Arr 2 : solar system with after-heating  
(PG 68.30 and PG 69.30)

## 4. Control parameters and display channels

### 4.1 Overview of channels

#### Legend:

x

Corresponding channel is available.

x\*

Corresponding channel is available when the corresponding option is enabled

PG 67.30 and 69.30 only

#### Please note:

Only if temperature sensors are connected, will S3 and S4 be displayed.

①

Only if the option heat quantity measurement is **activated** (OHQM), will the corresponding channel be available.

②

Only if the option heat quantity measurement is **deactivated** (OHQM), will the corresponding channel be available.

MEDT

Only if an antifreeze (MEDT) other than **water or Tyfocor LS / G-LS (MEDT 0 or 3)** is used, will the channel anti-freeze concentration (MED%) be displayed.

channel	Arr		description	page
	1	2*		
COL	x	x	Temperature collector 1	11
TST	x		Temperature store 1	11
TSTL		x	Temperature store 1 bottom	11
TSTU		x	Temperature store 1 at the top	11
S3	x		Temperature sensor 3	11
TRF	①	①	Temperature return sensor	11
S4	②	②	Temperature sensor 4	11
n %	x		Pump speed relay 1	11
n1 %		x	Pump speed relay 1	11
h P	x		Operating hours relay 1	11
h P1		x	Operating hours relay 1	11
h P2		x	Operating hours relay 2	11
kWh	①	①	Heat quantity kWh	12
MWh	①	①	Heat quantity MWh	12
Arr	1-2		Arrangement	9
DT O	x	x	Switch-on temperature difference	13
DT F	x	x	Switch-off temperature difference	13
DT S	x	x	Set temperature difference	13
RIS	x	x	Rise	13
S MX	x	x	Maximum temperature store 1	13
EM	x	x	Emergency temperature collector 1	14

\* Arrangement 2 applies to versions 68.30 and 69.30 only.

channel	Arr		description	page
	1	2		
OCX	x	x	Option collector cooling collector 1	14
CMX	x*	x*	Maximum temperature collector 1	14
OCN	x	x	Option minimum limitation collector 1	14
CMN	x*	x*	Minimum temperature collector 1	14
OCF	x	x	Option antifreeze collector 1	14
CFR	x*	x*	Antifreeze temperature collector 1	14
OREC	x	x	Option recooling	15
OTC	x	x	Option tube collector	15
AH O		x	Switch-on temp. for thermostat 1	15
AH F		x	Switch-off temp. for thermostat 1	15
OHQM		x	Option heat quantity measurement	12
FMAX	①	①	Maximum flowrate	12
MEDT	①	①	Antifreeze type	12
MED%	MEDT	MEDT	Antifreeze concentration	12
nMN	x		Minimum pump speed relay 1	16
n1MN		x	Minimum pump speed relay 1	16
HND1	x	x	Manual operation relay 1	16
HND2	x	x	Manual operation relay 2	16
LANG	x	x	Language	16
PROG	XX.XX		Program number	
VERS	X.XX		Version number	

#### 4.1.1 Collector temperature

##### COL:

Collector temperature  
display range: -40...+250 °C



Display of the current collector temperature.

- COL : collector temperature (1-collector system)

#### 4.1.2 Store temperatures

##### TST,TSTL,TSTU:

Store temperatures  
Display range: -40...+250 °C

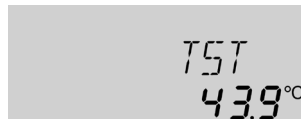

Display of the current store temperature.

- TST : store temperature (1-store system)
- TSTL : store base temperature,
- TSTU : store top temperature

#### 4.1.3 Sensor 3 and sensor 4

##### S3, S4:

Temperatures at the sensors  
S3 and S4  
Display range: -40...+250 °C

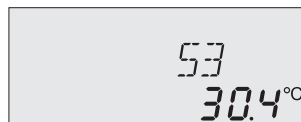

Display of the current temperature at the corresponding additional sensor (without control function).

- S3 : temperature - sensor 3
- S4 : temperature - sensor 4

##### Please note:

Only if the temperature sensors are connected (displayed), will S3 and S4 be displayed.

#### 4.1.4 Other temperatures

##### TRF:

other measured temperatures  
Display range: -40...+250 °C



Display of the current temperature at the sensor.

- TR : temperature - return

#### 4.1.5 Current pump speed

##### n %, n1 %:

current pump speed  
Display range: 30...100 %  
(PG 67.30 and PG 69.30)



Display of the current pump speed of the corresponding pump.

- n % : current pump speed (1-pump system)
- n1 % : current pump speed pump 1

#### 4.1.6 Operating hours counter

##### h P / h P1 / h P2:

Operating hours counter  
Display channel

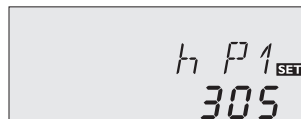

The operating hours counter accumulates the solar operating hours of the respective relay (h P / h P1 / h P2). Full hours are displayed.

The accumulated operating hours can be set back to zero. As soon as one operating hours channel is selected, the symbol **SET** is displayed. Press the SET (3) button for approx. 2 seconds in order to access the RESET-mode of the counter. The display symbol **SET** will flash and the operating hours will be set to 0. Confirm the reset with the **SET** button in order to finish the reset.

In order to interrupt the RESET-process, do not press a button for about 5 seconds. The display returns to the display mode.

#### 4.1.7 Heat quantity measurement option

**OHQM:** Heat quantity measurement  
Adjustment range: OFF...ON  
Factory setting: OFF



**FMAX:**  
Flow rate in l/min  
Adjustment range 0...20  
in 0,1-steps  
Factory setting: 6,0

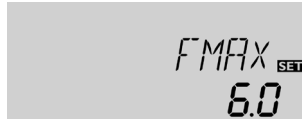

**MEDT:** Antifreeze type  
Adjustment range: 0...3  
Factory setting: 1



**MED%:** Antifreeze concentration (Vol-) %  
When water or ethylene glycol is used, the parameter MED% is ,hidden'.  
Adjustment range: 20...70  
Factory setting: 45



**kWh/MWh:** Heat quantity in kWh / MWh  
Display channel



Heat quantity measurement is possible if a flowmeter is used. For this purpose, the heat quantity measurement option (**OHQM**) has to be enabled.

The flow rate should be read from the flowmeter (l/min) and has to be adjusted in the channel **FMAX**. Antifreeze type and concentration of the heat transfer medium have to be adjusted in the channels **MEDT** and **MED%**.

#### Antifreeze type:

- 0 : water
- 1 : propylene glycol
- 2 : ethylene glycol
- 3 : Tyfocor® LS / G-LS

The flow rate as well as the reference sensors S1 (flow) and S4 (return) are used for calculating the heat quantity supplied. It is shown in kWh in the channel **kWh** and in MWh in the channel **MWh**. The overall heat quantity results from the sum of both values.

The accumulated heat quantity can be reset. As soon as one of the display channels of the heat quantity is selected, the symbol **SET** is permanently shown on the display. Press button SET (3) for about 2 seconds in order to access the RESET mode of the counter. The display symbol **SET** will flash and the heat quantity value will be set to 0. In order to finish this process, press the **SET** button to confirm.

In order to interrupt the RESET process, no button should be pressed for about 5 seconds. The controller automatically returns to the display mode.

#### 4.1.8 $\Delta T$ -regulation

##### DT O:

Switch-on temperature diff.  
Adjustment range: 1,0...20,0 K  
Factory setting: 6.0



##### DT F:

Switch-off temperature diff.  
Adjustment range  
0,5 ... 19,5 K  
Factory setting 4.0 K



**Please note:** Switch-on temperature difference DO must be at least 1 K higher than the switch-off temperature-difference DF.

##### DT S:

Set temperature difference  
Adjustment range:  
1,5...30,0 K  
Factory setting: 10.0 K  
(PG 67.30 and 69.30)

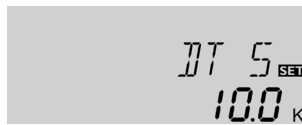

##### RIS:

Rise  
Adjustment range: 1 ... 20 K  
Factory setting: 2 K  
(PG 67.30 and PG 69.30)

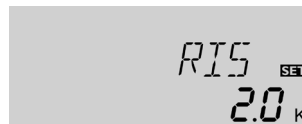

This function is a standard differential control. If the switch-on differential is reached (**DT O**), the pump is operated. The pump runs at 100% speed for 10 seconds. After this period, the pump runs at minimum pump speed (nMN = 30 %). If the switch-on difference reaches the adjusted set value (**DT S**) (PG 67.30 and PG 69.30 only), pump speed will increase by one step (10%). If the difference increases by 2 K (**RIS**) (PG 67.30 and PG 69.30 only), pump speed will increase by 10 % respectively until the maximum pump speed of 100 % is reached. The response of the controller can be adapted via the parameter „Rise“. If the temperature difference falls below the adjusted switch-off temperature difference (**DT F**), the controller switches off.

#### 4.1.9 Maximum store temperature

##### S MX:

Maximum store temp.  
Adjustment range: 2...95 °C  
Factory setting: 60 °C



If the adjusted maximum temperature is exceeded, the store will no longer be loaded in order to avoid damage caused by overheating. If the maximum store temperature is exceeded,  will be shown.

**Please note:** The controller is equipped with a store emergency shutdown function, which prevents the store from being loaded when the store temperature exceeds 95 °C.

#### 4.1.10 Collector emergency shutdown temperature

##### EM:

Collector emergency shutdown temperature  
Adjustment range: 110 ... 200 °C  
Factory setting: 140 °C



If the adjusted collector emergency shutdown temperature (**EM**) is exceeded, the controller will switch off the solar pump (R1) in order to protect the system against overheating (collector emergency shutdown). The factory setting is 140 °C but it can be changed within the adjustment range of 110...200 °C.  $\Delta$  (flashing) is displayed.

#### 4.1.11 System cooling

##### OCX:

System cooling option  
Adjustment range: OFF ... ON  
Factory setting: OFF



When the adjusted maximum store temperature is reached, the system stagnates. If the collector temperature increases to the adjusted maximum collector temperature (**CMX**), the solar pump is activated until the collector temperature falls below the maximum collector temperature. The store temperature may increase (subordinate active maximum store temperature), but only up to 95 °C (emergency shutdown of the store).

##### CMX:

Collector maximum temp.  
Adjustment range: 100...190 °C  
Factory setting: 120 °C



If **OREC** is additionally enabled:

If the store temperature is higher than the maximum store temperature (**SMX**) and if the collector temperature is at least 5 K below the store temperature, the solar system remains activated until the store is cooled down below the adjusted maximum temperature (**S MX**) via the collector and the pipework.

If the system cooling function is enabled,  $\star$  (flashing) is shown on the display. Due to the cooling function, the system will have a longer operation time on hot summer days and guarantees thermal relief of the collector field and the heat transfer fluid.

#### 4.1.12 Minimum collector function

##### OCN:

Minimum collector function  
Adjustment range: OFF / ON  
Factory setting: OFF

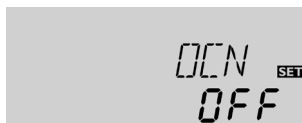

The minimum collector temperature is the minimum temperature which must be exceeded for the solar pump (R1) to switch on. The minimum temperature prevents the pump from being switched on too often at low collector temperatures. If the temperature falls below the minimum temperature,  $\star$  (flashing) is shown on the display.

##### CMN:

Minimum collector temperature  
Adjustment range: 10 ... 90 °C  
Factory setting: 10 °C



#### 4.1.13 Antifreeze function

##### OCF:

Antifreeze function  
Adjustment range: OFF / ON  
Factory setting: OFF



The antifreeze function activates the loading circuit between the collector and the store when the temperature falls below the adjusted antifreeze temperature. This will protect the fluid against freezing or coagulating. If the adjusted antifreeze temperature is exceeded by 1 °C, the loading circuit will be deactivated.

##### CFR:

Antifreeze temperature  
Adjustment range: -10 ... 10 °C  
Factory setting: 4,0 °C



##### Please note:

Since this function uses the limited heat quantity of the store, the antifreeze function should be used in regions with few days of temperatures around the freezing point.

#### 4.1.14 Recooling function

##### OREC:

recooling function option

Adjustment range:

OFF...ON

Factory setting: OFF



If the adjusted maximum store temperature (**S MX**) is reached, the controller keeps the solar pump running in order to prevent the collector from being overheated. The store temperature may increase but only up to 95 °C (emergency shutdown of the store).

The solar pump is switched on once the collector temperature is lower than the store temperature. It is switched off when the store is cooled down to the adjusted maximum temperature via the collector and the pipework.

#### 4.1.15 Tube collector function

##### OTC:

Tube collector function

Adjustment range:

OFF...ON

Factory setting: OFF



If the controller detects an increase in collector temperature by 2 K compared to the previously stored collector temperature, the solar pump will be switched-on at 100 % for about 30 seconds in order to detect the fluid temperature. The current collector temperature will be saved as a new reference value. If the measured temperature (new reference value) is exceeded by 2 K, the solar pump will run for 30 seconds. If the switch-on difference between the collector and the store is exceeded during the runtime of the solar pump or the standstill of the system, the controller will automatically switch to solar loading.

If the collector temperature decreases by 2 K during standstill, the switch-on value for the tube collector function will be recalculated.

#### 4.1.16 Thermostat function

(Arr = 2)

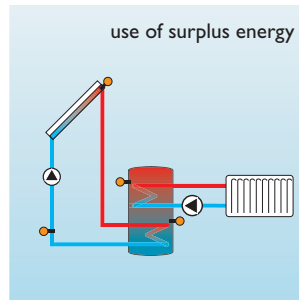
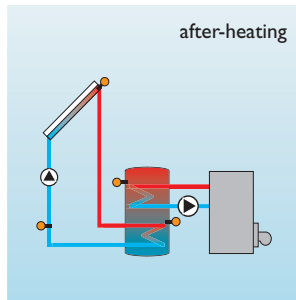

The thermostat function works independently from the solar operation and can be used for using surplus energy or for after-heating.

- **AH O < AH F**  
thermostat function for after-heating
- **AH O > AH F**  
thermostat function for using surplus energy

When the 2nd relay output is active,  $\text{II}$  is displayed.



##### AH O:

Thermostat-switch-on temperature

Adjustment range:

0,0...95,0 °C

Factory setting: 40,0 °C



##### AH F:

Thermostat-switch-off temperature

Adjustment range:

0,0...95,0 °C

Factory setting: 45,0 °C

#### 4.1.17 Pump speed control

##### nMN:

Pump speed control  
Adjustment range:  
30...100  
Factory setting: 30  
(PG 67.30 and PG 69.30)

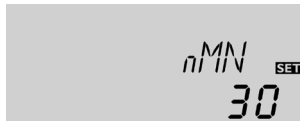

A relative minimum pump speed is allocated to the output R1 via the adjustment channel **nMN**.

##### Attention:

**When loads which are not speed controlled (e.g. valves) are used, the value must be changed to 100% in order to deactivate pump speed control.**

#### 4.1.18 Operating mode

##### HND1 / HND2:

Operating mode  
Adjustment range:  
OFF,AUTO, ON  
Factory setting:AUTO

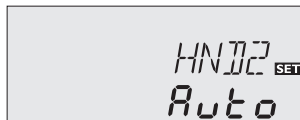
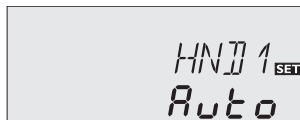

For control and service work, the operating mode of the controller can be manually adjusted. For this purpose, select the adjustment value HND1 / HND2. The following adjustments can be carried out:

##### • HND1 / HND2

Operating mode

- OFF : relay off ⚠ (flashing) + 🖐
- AUTO : relay in automatic operation
- ON : relay on ⚠ (flashing) + 🖐

#### 4.1.19 Language

##### LANG:

Language choice  
Adjustment range:  
dE, En, It, Fr  
Factory setting: En



In this channel, different languages are available.

- dE : German
- En : English
- It : Italiano
- Fr : French

### 5. Troubleshooting

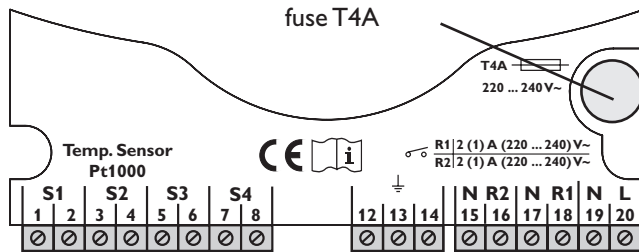

If a malfunction occurs, a message is displayed in the display of the controller:

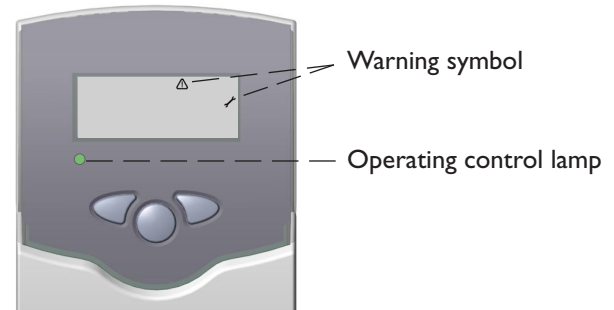

Operating control lamp flashes red. The symbol and the are shown.

Sensor fault. An error code instead of a temperature is shown on the sensor display channel.

888.8

- 88.8

Cable is broken. Check the cable.

Short-circuit. Check the cable.

Disconnected Pt1000 temperature sensors can be checked with an ohmmeter. In the following table, the resistance values corresponding to different temperatures are listed.

°C	Ω	°C	Ω
-10	961	55	1213
-5	980	60	1232
0	1000	65	1252
5	1019	70	1271
10	1039	75	1290
15	1058	80	1309
20	1078	85	1328
25	1097	90	1347
30	1117	95	1366
35	1136	100	1385
40	1155	105	1404
45	1175	110	1423
50	1194	115	1442

Resistance values of the Pt1000-sensors

Operating control lamp off

Check the power supply

o.k.

The fuse of the controller could be blown. It can be replaced after the front cover has been removed (spare fuse is enclosed in the accessory bag).

5.1 Various:

Pump is overheated, but no heat transfer from the collector to the store, flow and return have the same temperature; perhaps also bubble in the lines

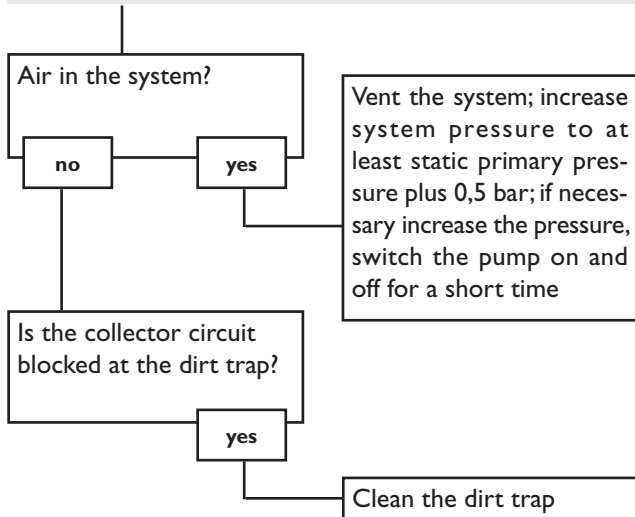

Pump starts for a short moment, switches-on/off again, etc.

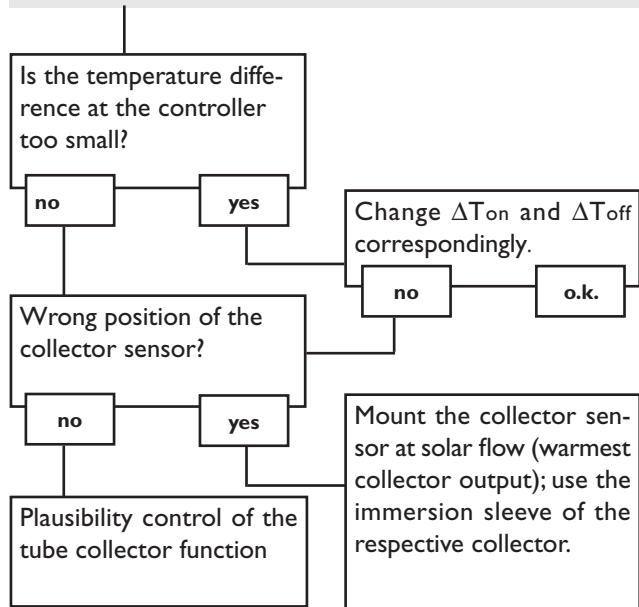

Pump starts up very late..

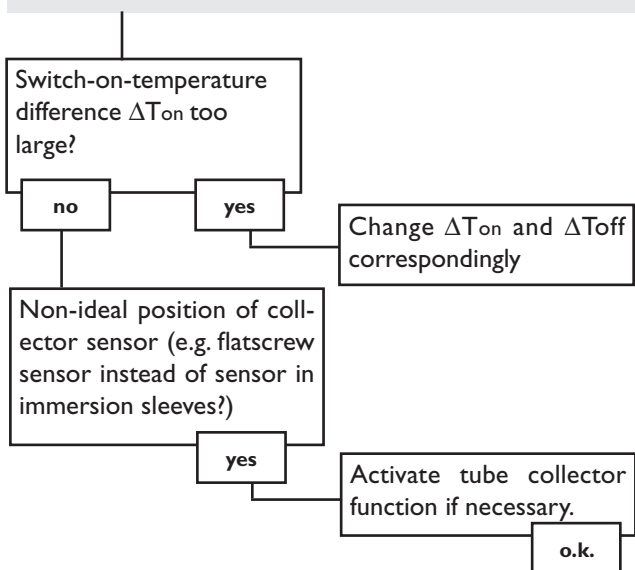

The temperature difference between the store and the collector increases enormously during operation; the collector circuit cannot divert the heat.

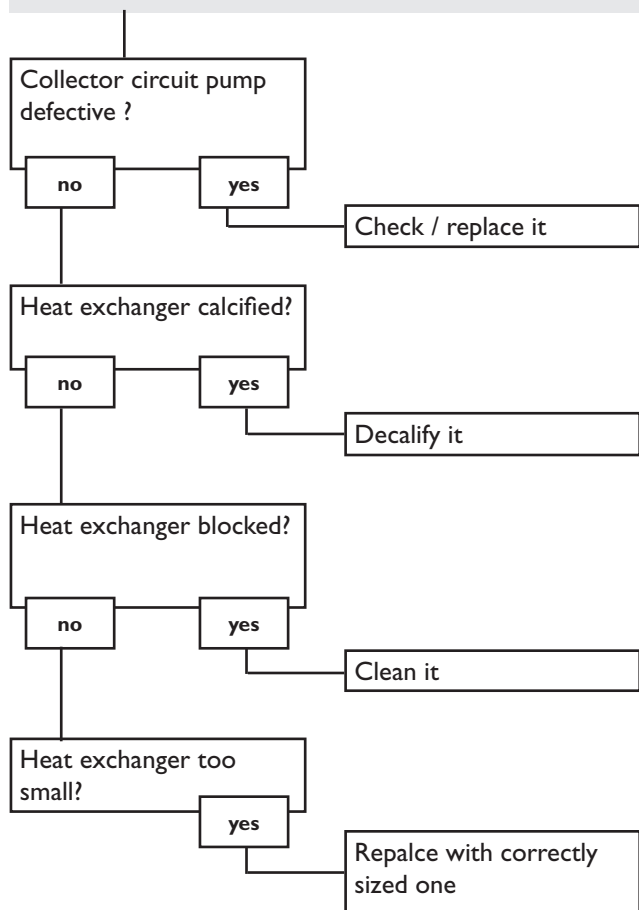

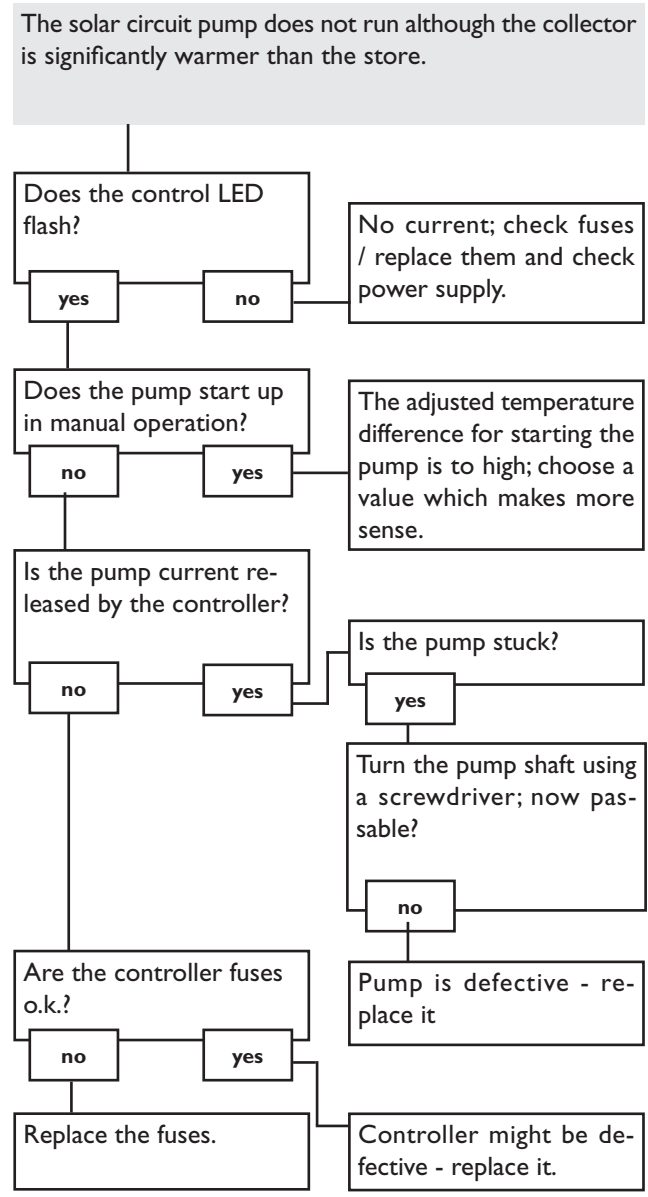
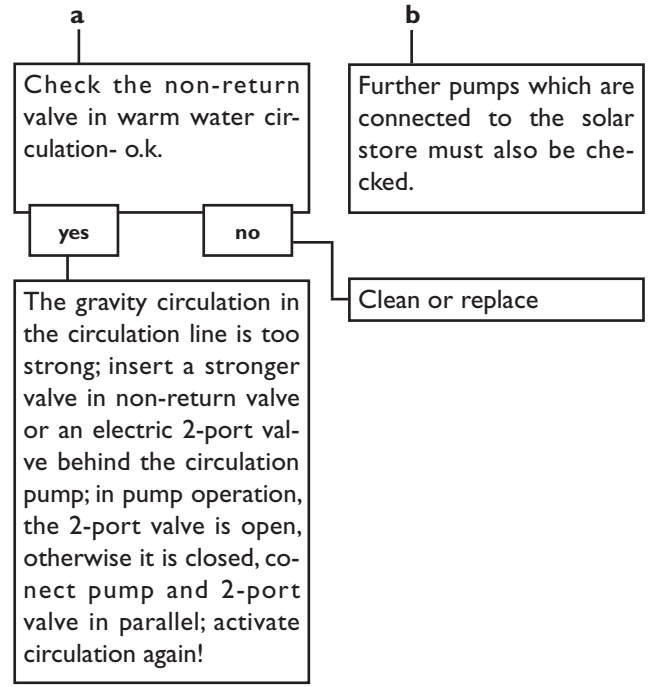
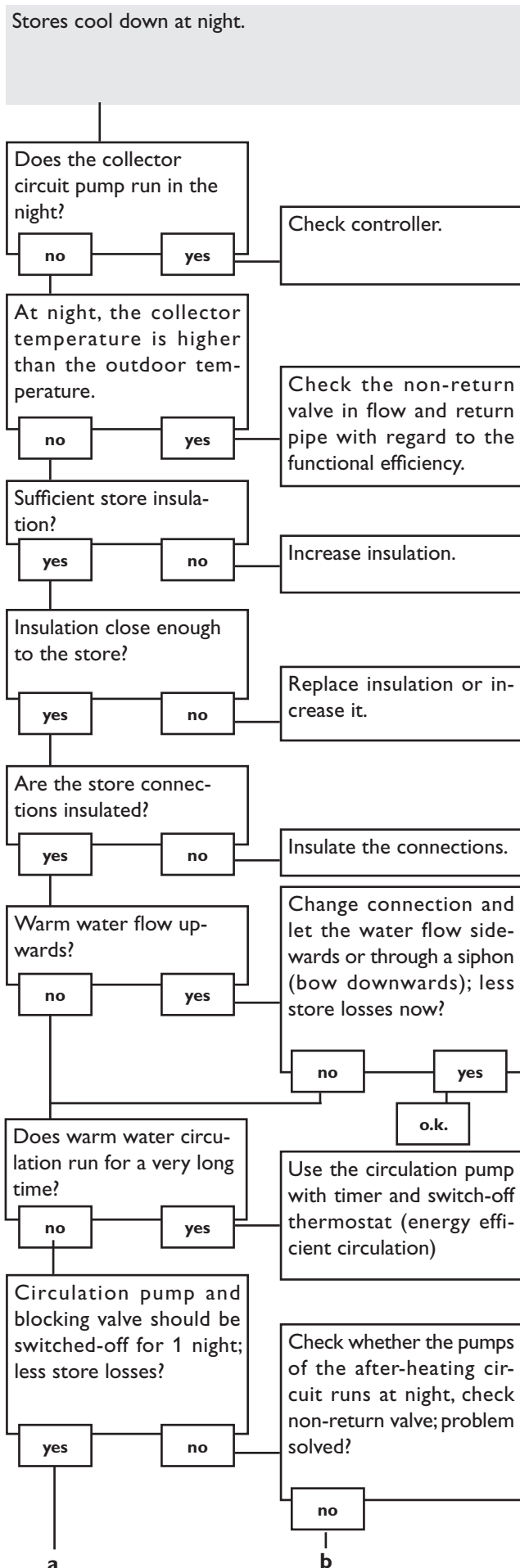

## 6. Accessory

### Sensors

Our product range includes high-precision platinum temperature sensors, flatscrew sensors, outdoor temperature sensors, indoor temperature sensors, cylindrical clip-on sensors and irradiation sensors, also as complete sensors with immersion sleeve.



### Overvoltage protection device

In order to avoid overvoltage damage at collector sensors (e.g. caused by local lightning storms), we recommend installing the overvoltage protection RESOL SP1.



### Flowmeter

If you wish to carry out a heat quantity measurement, you need a flowmeter for measuring the flow rate in your system.



### Distributed by:

#### RESOL - Elektronische Regelungen GmbH

Heiskampstraße 10  
45527 Hattingen / Germany  
Tel.: +49 (0) 23 24 / 96 48 - 0  
Fax: +49 (0) 23 24 / 96 48 - 55  
[www.resol.de](http://www.resol.de)  
[info@resol.de](mailto:info@resol.de)

### Important notice:

We took a lot of care with the texts and drawings of this manual and to the best of our knowledge and consent. As faults can never be excluded, please note: Your own calculations and plans, under consideration of the current standards and DIN-directions should only be basis for your projects. We don't offer a guarantee for the completeness of the drawings and texts of this manual - they only represent some examples. They can only be used at your own risk. No liability is assumed for incorrect, incomplete or false information and / or any resulting damages.

### Reprinting / copying

This mounting- and operation manual including all parts is copyrighted. Another use outside the copyright requires the approval of RESOL - Elektronische Regelungen GmbH. This especially applies for copies, translations, micro films and the storage into electronic systems.  
Editor: RESOL - Elektronische Regelungen GmbH

### Please note:

The design and the specifications can be changed without prior notice. The illustrations may differ from the original product.