



**taconova**

comfort solutions

**TACOFLOW3**

**TACOFLOW3 DUO**



EA.1414 / 216957 / E9206500 / 7/2024

**QUICK GUIDE**

**EN** The installation, maintenance or repair of the circulators must be carried out by authorized personnel and only original spare parts and accessories are to be used. Using the circulators for purposes other than those specified in the instructions is prohibited and considered inappropriate unless previously agreed to in writing with TACO ITALIA S.r.L./ Taconova Production s.r.o.



**ATTENTION:** If the packaging and/or the circulator are visibly damaged, the circulator must absolutely not be used.

**DE** Die Installation, Wartung oder Reparatur der Pumpen darf nur von autorisiertem Personal durchgeführt werden. Es dürfen nur Original-Zubehör oder Originalersatzteile eingesetzt werden. Jegliche Nutzung der Pumpen die von der Gebrauchsanweisung abweicht, ist verboten und wird als Missbrauch betrachtet, sofern nicht vorab schriftlich mit TACO ITALIA S.r.L./ Taconova Production s.r.o. vereinbart.

**ACHTUNG:** sollten die Verpackung und/oder die Pumpe sichtbar beschädigt sein, darf die Pumpe auf keinen Fall zum Einsatz kommen.

**IT** L'installazione, manutenzione o riparazione dei circolatori deve essere effettuata da persone autorizzate e non è consentito l'uso di accessori e parti di ricambio non originali. Utilizzi delle pompe diversi da quelli indicati nelle istruzioni sono vietati e ritenuti usi impropri se non preventivamente concordati in forma scritta con TACO ITALIA S.r.L./ Taconova Production s.r.o.

**ATTENZIONE:** qualora l'imballaggio e/o il circolatore risultino visibilmente danneggiati, il circolatore non deve essere assolutamente utilizzato.

**BG** Инсталирането, поддръжката или ремонтът на циркулационните помпи трябва да се извърши от оторизирани лица и не се разрешава използването на аксесоари и резервни части, които не са оригинални. Използването на циркулационните помпи за цели, различни от посочените в инструкциите, е забранено и се счита за неподходящо, освен ако не е предварително договорено писмено с TACO ITALIA S.r.L./ Taconova Production s.r.o.

**ВНИМАНИЕ!** Ако опаковката и/или циркулационната помпа са видимо повредени, в никакъв случай не трябва да се използва циркулационната помпа.

**CZ** Instalaci, údržbu i opravy cirkulátorů musí provádět autorizované osoby. Není dovoleno použití jiného než originálního příslušenství a náhradních dílů. Používání oběhových čerpadel k jiným účelům, než jsou uvedeny v pokynech, je zakázáno a považováno za nevhodné, pokud to nebylo předem písemně dohodnuto se společností TACO ITALIA S.r.L./ Taconova Production s.r.o. **UPOZORNĚNÍ:** pokud je viditelné poškození balení či cirkulátoru, nesmí se cirkulátor v žádném případě používat.

**DA** Installation, vedligeholdelse eller reparation af cirkulatorerne bør kun udføres af autoriseret personale og anvendelse af tilbehør og reservedele, som ikke er originale, er ikke tilladt. Brug af pumperne til andre formål end dem, der er angivet i instruktionerne, er forbudt og anses for upassende, medmindre det på forhånd er aftalt skriftligt med TACO ITALIA S.r.L./ Taconova Production s.r.o.

**ADVARSEL:** hvis emballagen og/eller cirkulatoren er tydeligt beskadiget, må cirkulatoren ikke anvendes på nogen måde.

**EL** Η εγκατάσταση, συντήρηση και επιδιόρθωση των κυκλοφορητών θα πρέπει να διενεργείται από εξουσιοδοτημένο [τεχνικό] προσωπικό. Η χρήση μη γνήσιων αξεσουάρ ή ανταλλακτικών απαγορεύεται. Η χρήση των αντλιών για σκοπούς άλλους από αυτούς που

καθορίζονται στις οδηγίες απαγορεύεται και θεωρείται ακατάλληλη, εκτός εάν έχει προηγουμένως συμφωνηθεί γραπτώς με την TACO ITALIA S.r.L./ Taconova Production s.r.o.



**ΠΡΟΣΟΧΗ:** απαγορεύεται η χρήση του κυκλοφορητή στην περίπτωση που η συσκευασία ή/και ο κυκλοφορητής είναι εμφανώς κατεστραμμένοι.

**ES** La instalación, la reparación y el mantenimiento de los circuladores deben ser efectuados por personas autorizadas y no está permitido utilizar accesorios o piezas de repuesto no originales. El uso de las bombas para fines distintos a los especificados en las instrucciones está prohibido y se considera inapropiado a menos que se acuerde previamente por escrito con TACO ITALIA S.r.L./ Taconova Production s.r.o.

**ATENCIÓN:** en caso de que el embalaje o el circulador presenten daños visibles, no utilice el circulador por ningún motivo.

**ET** Tsirkulatsioonipumpade paigalduse, hoolduse ja remondi peab teostama selleks volitatud personal ning kasutada on võib vaid originaalvaruosi ja -tarvikuid. Pumpade kasutamine muudel kui juhendis määratletutel eesmärkidel on keelatud ja seda peetakse sobimatuks, välja arvatud juhul, kui selles on eelnevalt kirjalikult kokku lepitud ettevõttega TACO ITALIA S.r.L./ Taconova Production s.r.o.

**TÄHELEPANU:** kui pakend ja/või tsirkulatsioonipump on nähtavalt kahjustatud, ei tohi tsirkulatsioonipumpa mitte mingil juhul kasutada.

**FR** L'installation, la maintenance ou la réparation des circulateurs doit être effectuée par des personnes autorisées et l'usage d'accessoires et de pièces de rechange non originaux n'est pas permis. L'utilisation des pompes à des fins autres que celles spécifiées dans les instructions est interdite et considérée comme inappropriée, sauf accord préalable écrit avec TACO ITALIA S.r.L./ Taconova Production s.r.o.

**ATTENTION:** Si l'emballage et/ou le circulateur sont visiblement endommagés, le circulateur ne doit absolument pas être utilisé.

**FI** Kiertoelimet saa asentaa, huoltaa tai korjata ainoastaan valtuutetut henkilöt. Muiden kuin alkuperäisten lisävarusteiden ja varaosien käyttö on kiellettyä. Pumpujen käyttö muihin kuin ohjeissa mainittuihin tarkoituksiin on kiellettyä ja katsotaan sopimattomaksi, ellei siitä ole etukäteen sovittu kirjallisesti TACO ITALIA S.r.L./ Taconova Production s.r.o. n kanssa.

**HUOMIO:** Kun pakkaus ja/tai kiertoelin on selkeästi vaurioitunut, kiertoelintä ei saa misään tapauksessa käyttää.

**HR** Montažu, održavanje i popravak cirkularnih pumpi trebaju obavljati isključivo ovlaštene osobe. Dopušteno je korištenje isključivo originalnih zamjenskih rezervnih dijelova i dodatne opreme. Korištenje pumpi u svrhe koje nisu navedene u uputama je zabranjeno i smatra se neprikladnim osim ako prethodno nije dogovoreno u pisanom obliku s TACO ITALIA S.r.L./ Taconova Production s.r.o.

**OPREZ:** ako su pakiranje i/ili cirkularna pumpa vidno oštećeni, zabranjeno je korištenje pumpe.

**HU** A keringető szivattyú összeszerelését, karbantartását és javítását csak erre felhatalmazott személyek végezhetik és nem megengedett a nem eredeti tartozékok és pótkatrészek használata. A szivattyúkat az útmutatóban meghatározottaktól eltérő célokra használni tilos, és nem tekinthető megfelelőnek, kivéve, ha előzetesen írásban megállapodtak a TACO ITALIA S.r.L./ Taconova Production s.r.o.-vel.

**FIGYELEM:** amennyiben a csomagolás és/vagy a keringető szivattyú láthatóan sérültnek bizonyul, szigorúan tilos a keringető szivattyú használata.

**IS** Uppsetning, viðtal eða viðgerðir á hringtengjunum verður að vera framkvæmd af viðurkenndu starfsfólki þar sem aðeins upprunalegir varahlutir og aukahlutir eru notaðir. Notkun dælanna í öðrum tilgangi en þeim sem tilgreind eru í leiðbeiningunum er bönnuð og talin óviðeigandi nema áður hafi verið samið skriflega við TACO ITALIA S.r.L./Taconova Production s.r.o.



**ATHUGIÐ:** Ef umbúðirnar og/eða hringtengin eru sýnilega skemmd má alls ekki nota hringtengin.

**LT** Cirkuliacinius siurblius montuoti, atlikti jų techninę priežiūrą ar remontą gali tik įgalioti darbuotojai naudodami tik originalias dalis ir priedus. Draudžiama naudoti cirkuliacinius siurblius kitiems tikslams, nei nurodyta instrukcijose, ir laikoma netinkama, nebent iš anksto buvo susitarta raštu su TACO ITALIA S.r.L./ Taconova Production s.r.o.

**DĒMĒSIO:** Jei pakuoūtė ir [arba] cirkuliacinis siurblys yra akivaizdžiai pažeisti, cirkuliacinio siurblio naudoti negalima.

**LV** Cirkulācijas sūkņu uzstādīšanu, apkopi un remontu jāveic pilnvarotam personālam, izmantojot vienīgi oriģinālās rezerves daļas un piederumi. Naudoti siurbļus kitiems tikslams, nei nurodyta instrukcijose, draudžiama ir laikoma netinkama, nebent dėl to būtų susitarta raštu su TACO ITALIA S.r.L./ Taconova Production s.r.o.

**UZMANĪBU:** ja iepakojumam un/vai cirkulācijas sūknim ir manāmi bojājumi, cirkulācijas sūkni nekādā gadījumā nedrīkst izmantot.

**NL** De installatie, het onderhoud of de reparatie van de verspreiders moet toevertrouwd worden aan geautoriseerd personeel. Het gebruik van niet-originele accessoires en wisselonderdelen is niet toegestaan. Het gebruik van de circulatoren voor andere doeleinden dan gespecificeerd in de instructies is verboden en wordt als ongepast beschouwd, tenzij dit vooraf schriftelijk is overeengekomen met TACO ITALIA S.r.L./Taconova Production s.r.o.

**OPGELET:** indien de verpakking en/of de verspreider zichtbare schade vertonen, dient de verspreider in geen geval in gebruik genomen te worden.

**NO** Installasjon, vedlikehold og reparasjon av sirkulatorer må utføres av godkjente personer og bruk av tilbehør og reservedeler som ikke er originale er ikke tillatt. Bruk av pumpene til andre formål enn de som er spesifisert i instruksjonene er forbudt og anses som upassende med mindre det på forhånd er skriftlig avtalt med TACO ITALIA S.r.L./ Taconova Production s.r.o.

**ADVARSEL:** hvis emballasjen og/eller sirkulatoren har tydelige skader, må sirkulatoren absolutt ikke tas i bruk.

**PL** Instalacja, konserwacja czy naprawa pomp cyrkulacyjnych powinna być przeprowadzana przez osoby do tego upoważnione. Nie jest dozwolone używanie nieoryginalnych akcesoriów lub części zamiennych. Używanie pomp do celów innych niż określone w instrukcji jest zabronione i uważane za niewłaściwe, chyba że zostało to wcześniej uzgodnione na piśmie z TACO ITALIA S.r.L./ Taconova Production s.r.o.

**UWAGA:** W razie widocznych uszkodzeń opakowania i/lub pompy cyrkulacyjnej, nie powinna być ona absolutnie używana.

**PT** A instalação, manutenção ou reparação dos circuladores deve ser realizada por pessoal autorizado e não é permitida a utilização de acessórios e peças sobresselentes não originais. A utilização das bombas para fins diferentes dos especificados nas instruções é proibida e considerada inadequada, a menos que previamente acordado por escrito com a TACO ITALIA S.r.L./ Taconova Production s.r.o.

**ATENÇÃO:** caso a embalagem e/ou o circulador estejam visivelmente danificados, o circulador não deve ser de todo usado.

**RU** Монтаж, техническое обслуживание и ремонт циркуляционных насосов должны производиться персоналом, имеющим допуск к выполнению указанных работ. Запрещено использование неоригинальных приспособлений и запасных частей. Использование насосов для целей, отличных от указанных в инструкциях, запрещено и считается нецелесообразным, если это не было предварительно согласовано в письменной форме с TACO ITALIA S.r.L./ Taconova Production s.r.o. **ВНИМАНИЕ!** Если циркуляционный насос и/или его упаковка имеют видимые повреждения, категорически запрещено использовать такой циркуляционный насос.



**RO** Instalarea, întreținerea și repararea pompelor de circulație va fi efectuată de către persoane autorizate. Nu se admite utilizarea de accesorii și piese de schimb care nu sunt de origine. Utilizarea pompelor în alte scopuri decât cele specificate în instrucțiuni este interzisă și considerată inadecvată, cu excepția cazului în care sa convenit anterior în scris cu TACO ITALIA S.r.L./ Taconova Production s.r.o.

**ATENȚIE:** dacă ambalajul sau/și pompa de circulație sunt vizibil deteriorate, pompa nu va fi, în niciun caz, utilizată.

**SV** Installation, underhåll eller reparation av cirkulatorer ska utföras av auktoriserade personer och det är inte tillåtet att använda icke originaltillbehör och -reservdelar. Att använda pumparna för andra ändamål än de som anges i instruktionerna är förbjudet och anses olämpligt såvida inte tidigare skriftligen överenskommits med TACO ITALIA S.r.L./ Taconova Production s.r.o.

**OBSERVERA!** Om förpackningen och/eller cirkulatorn visar sig vara skadad vid en visuell kontroll, får cirkulatorn på inga villkor användas.

**SK** Montáž, údržbu alebo opravu obehových čerpadiel musí vykonať oprávnená osoba, nie je povolené používanie neoriginálneho príslušenstva a náhradných dielov. Používanie čerpadiel na iné účely, ako sú tie, ktoré sú uvedené v pokynoch, je zakázané a považuje sa za nevhodné, pokiaľ nie je vopred písomne dohodnuté so spoločnosťou TACO ITALIA S.r.L./ Taconova Production s.r.o.

**UPOZORNENIE:** v prípade, ak obal a/alebo čerpadlo nesú viditeľné známky poškodenia, čerpadlo nesmie byť uvedené do používania.

**SL** Obtočne črpalke sme namestiti, vzdrževati in popravljati izključno usposobljeno osebje. Uporaba neoriginalnih priključkov in nadomestnih delov je prepovedana. Uporaba črpalk za namene, ki niso navedeni v navodilih, je prepovedana in velja za neprimerno, razen če je predhodno pisno dogovorjeno s TACO ITALIA S.r.L./ Taconova Production s.r.o.

**POZOR:** v primeru, da sta embalaža in/ali obtočna črpalka vidno poškodovani, se slednje ne sme uporabljati.

**TR** Pompaların kurulum, bakım ya da onarım işlemleri yetkili kişiler tarafından gerçekleştirilmelidir. Orijinal olmayan yedek parça ve aksesuarların kullanımı yasaktır. Pompaların talimatlarda belirtilen amaçlar dışında kullanılması yasaktır ve TACO ITALIA S.r.L./ Taconova Production s.r.o. ile önceden yazılı olarak mutabakata varılmadıkça uygunsuz kabul edilir.

**DİKKAT:** Ambalajda ve/veya dış muhafazasında gözle görülür hasar mevcutsa, pompa kesinlikle kullanılmamalıdır.

# EEl – Energy Efficiency Index

## Mode / Modus / Modalità / Modalidad / Tryb / Režim / Λειτουργία

TacoFlow3:	dp-c (x3), dp-v (x3), min-max
TacoFlow3 ADAPT:	TacoAdapt™, dp-c (x3), dp-v (x3), min-max
TacoFlow3 SURFACE:	max, dp-v (x1), dp-c (Cmin ... Cmax)
TacoFlow3 DUO:	dp-c (x3), dp-v(x3), min-max
TacoFlow3 DUO ADAPT:	TacoAdapt™, dp-c (x3), dp-v(x3), min-max
TacoFlow3 DUO HYBRID:	TacoAdapt™, dp-c (x3), dp-v(x1), min-max, PWM S, PWM H

EEl ≤ 0,19 - Part 2	TacoFlow3 x-60/y TacoFlow3 ADAPT x-60/y TacoFlow3 SURFACE x-60/y TacoFlow3 DUO x-60/y TacoFlow3 DUO ADAPT x-60/y TacoFlow3 DUO HYBRID x-60/y
EEl ≤ 0,20 - Part 2	TacoFlow3 x-85/y TacoFlow3 ADAPT x-85/y TacoFlow3 SURFACE x-85/y TacoFlow3 DUO x-85/y TacoFlow3 DUO ADAPT x-85/y TacoFlow3 DUO HYBRID x-85/y

x	60 / 85	y
15 = DN15 (G1")	60 = 6.0m, 0.6 bar, 60 kPa	130 = 130 mm
25 = DN25 (G1 ½")	85 = 8.5m, 0.85 bar, 85 kPa	180 = 180 mm
32 = DN32 (G2")		

- EN** The benchmark for the most efficient circulators is  $E_{EEI} \leq 0,20$
- DE** Referenzwert für die effizientesten Umwälzpumpen ist  $E_{EEI} \leq 0,20$
- IT** Il parametro di riferimento per i circolatori più efficienti è  $IEE \leq 0,20$
- BG** Базовата стойност за сравнение за най-ефективните циркуляционни помпи е  $IEE \leq 0,20$
- CZ** Referenční hodnota nejúčinnějších oběhových čerpadel je  $E_{EEI} \leq 0,20$
- DA** Referenceværdien for de mest effektive cirkulationspumper er  $E_{EEI} \leq 0,20$
- EL** Το κριτήριο συγκριτικής αξιολόγησης για τους αποδοτικότερους κυκλοφορητές είναι  $E_{EEI} \leq 0,20$
- ES** El índice de referencia de los circuladores más eficientes es  $IEE \leq 0,20$
- ET** Kõige tõhusamate ringluspumpade energiatõhususe indeks:  $E_{EEI} \leq 0,20$
- FR** Le critère de référence pour les circulateurs les plus efficaces est  $IEE \leq 0,20$
- FI** Tehokkaimpien kiertovesipumppujen viitearvo on  $E_{EEI} \leq 0,20$
- HR** Mjerilo za najučinkovitijih Circulators je  $E_{EEI} \leq 0,20$
- HU** A leghatékonyabb keringetőszivattyúkra vonatkozó referenciaérték  $E_{EEI} \leq 0,20$
- IS** Viðmiðin fyrir mestu skilvirkni hringrásadæla er  $E_{EEI} \leq 0,20$
- LT** Veiksmingiausių apytakinių siurblių energijos vartojimo efektyvumo koeficiento etalonas yra  $\leq 0,20$
- LV** Efektīvāko cirkulācijas sūkņu kritērijs ir  $E_{EEI} \leq 0,20$
- NL** De benchmark voor de meeste efficiënte circulatiepompen is  $E_{EEI} \leq 0,20$
- NO** Referanseverdi for de mest effektive sirkulasjonspumpene er  $E_{EEI} \leq 0,20$
- PL** Kryterium odniesienia dla najbardziej energooszczędnych pomp cyrkulacyjnych wynosi  $E_{EEI} \leq 0,20$
- PT** Parâmetro de referência para as bombas de circulação mais eficientes:  $IEE \leq 0,20$
- RU** Базовое значение для самых эффективных циркуляционных насосов составляет  $E_{EEI} \leq 0,20$
- RO** Valoarea de referință pentru cele mai eficiente pompe de circulație este  $E_{EEI} \leq 0,20$
- SV** Riktmärket för de mest effektiva cirkulationspumparna är  $E_{EEI} \leq 0,20$
- SK** Referenčná hodnota pre najúčinnějšíe obehové čerpadlá je  $E_{EEI} \leq 0,20$
- SL** Merilo uspešnosti za najučinkovitejše črpalke je  $E_{EEI} \leq 0,20$
- TR** En verimli sirkülasyon pompaları için referans değeri  $E_{EEI} \leq 0,20$

# TacoFlow3

## \_, ADAPT, SURFACE



MIN	MAX
<b>@75°C:</b> 0.005 MPa (0.05 bar)	0.6 MPa (6 bar)
<b>@85°C:</b> 0.025 MPa (0.25 bar)	
<b>@95°C:</b> 0.055 MPa (0.55 bar)	

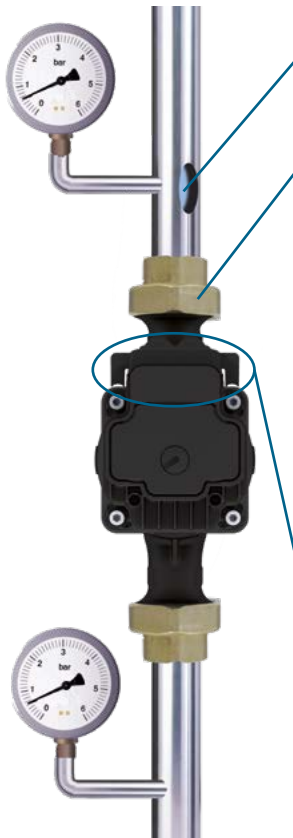

Glycol: max 40%

DN15 DN25 DN32  
1" 1½" 2"

TacoSmart



> p. 18

Plug & Play



> p. 17

If possible, keep cables away from the housing.  
Wenn möglich, Kabel vom Gehäuse fernhalten.

Se possibile, tenere il cavo lontano dall'alloggiamento.



Max. 95% RH  
IP44



< 33 dB(A)



# TacoFlow3

## \_, ADAPT, SURFACE



Min. +0°C / +32°F  
Max. +55°C / +131°F



Min. +2°C / +36°F  
Max. +95°C / +203°F

°C
0
10
20
30
40
50
55

MIN (°C)	MAX (°C)
2	95
10	95
20	95
30	95
40	95
50	95
55	95



≤



EN: No condensation  
DE: Kein Kondenswasser  
IT: Nessuna condensa  
CZ/SL: Bez kondenzace  
PL: Brak kondensacji  
FR: Pas de condensation  
ES: Sin condensación  
PT: Sem condensação  
EL: Καμία συμπύκνωση  
SW/NO: Ingen kondens  
NL: Ingen kondens  
RO: Fără condensare

# TacoFlow3 DU0

## \_ , ADAPT, HYBRID



MIN	MAX
<b>@75°C:</b> 0.005 MPa (0.05 bar)	1.0 MPa (10 bar)
<b>@85°C:</b> 0.025 MPa (0.25 bar)	
<b>@95°C:</b> 0.055 MPa (0.55 bar)	

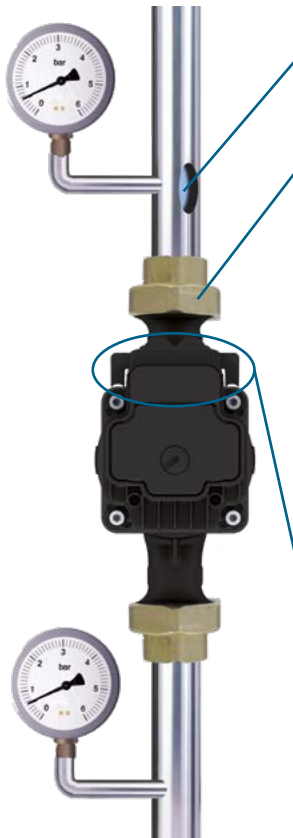

Glycol: max 40%

DN15 DN25 DN32  
1" 1½" 2"

TacoSmart



> p. 18

Plug & Play



> p. 17

If possible, keep cables away from the housing.  
Wenn möglich, Kabel vom Gehäuse fernhalten.

Se possibile, tenere il cavo lontano dall'alloggiamento.



Max. 95% RH  
IP44



< 33 dB(A)

# TacoFlow3 DU0

\_, ADAPT, HYBRID



Min. +0°C / +32°F  
Max. +40°C / +104°F



Min. +2°C / +36°F  
Max. +110°C / +230°F

°C
0
10
20
30
40
45
60

MIN (°C)	MAX (°C)
2	110
10	110
20	110
30	110
40	110
45	100
60	95



≤



EN: No condensation  
DE: Kein Kondenswasser  
IT: Nessuna condensa  
CZ/SL: Bez kondenzace  
PL: Brak kondensacji  
FR: Pas de condensation  
ES: Sin condensación  
PT: Sem condensação  
EL: Καμία συμπύκνωση  
SW/NO: Ingen kondens  
NL: Ingen kondens  
RO: Fără condensare

# Performance curves 6 m

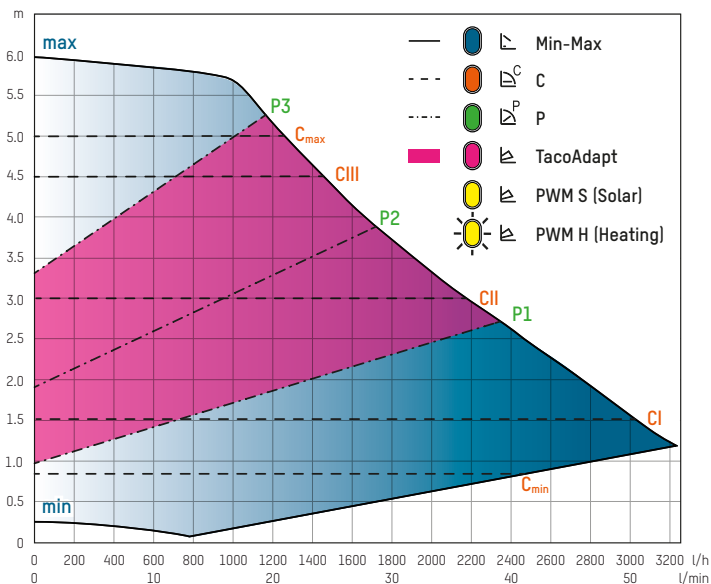

Q [l/h]	800	1200	1600	2000	2400	2800	3200	3600
H [m]	5.8	5.2	4.1	3.3	2.6	1.9	1.2	N/A

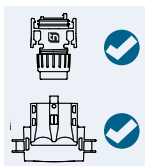

# Power curves 6 m

Constant pressure ( $\Delta p-c$ )

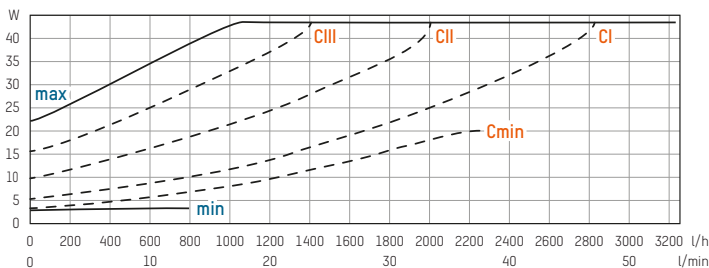

Proportional pressure ( $\Delta p-v$ )

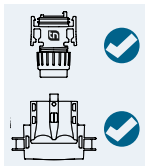
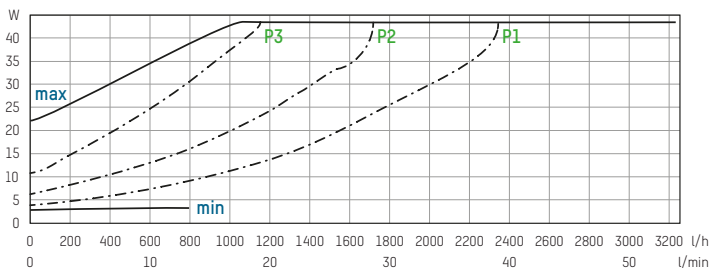

# Performance curves 8.5 m

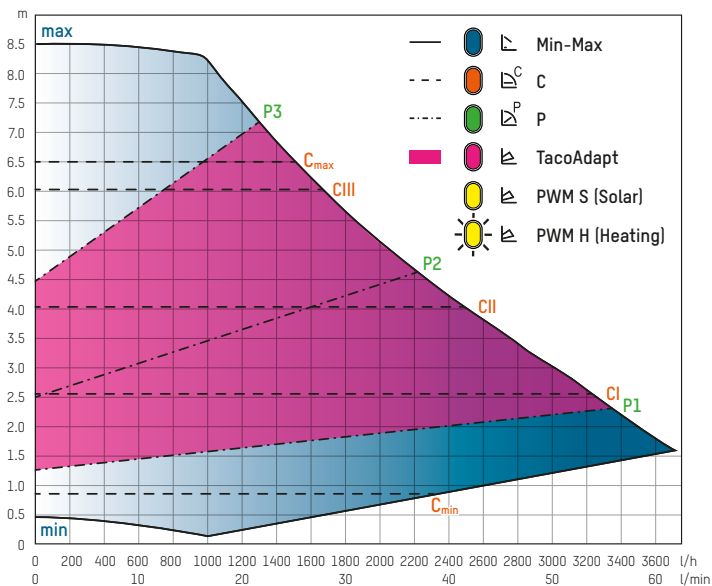

Q [l/h]	800	1200	1600	2000	2400	2800	3200	3600
H [m]	8.4	7.5	6.2	5.1	4.2	3.4	2.6	1.8

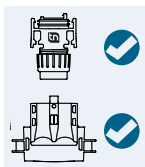

# Power curves 8.5 m

Constant pressure ( $\Delta p-c$ )

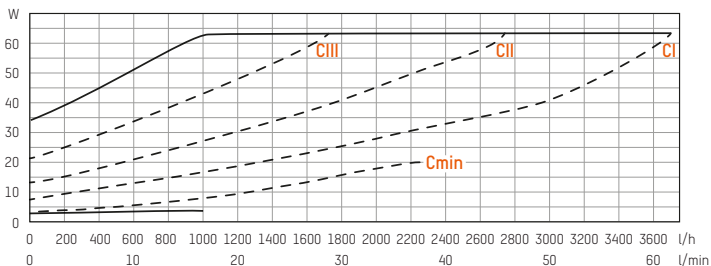

Proportional pressure ( $\Delta p-v$ )

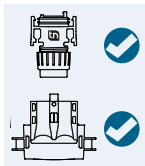
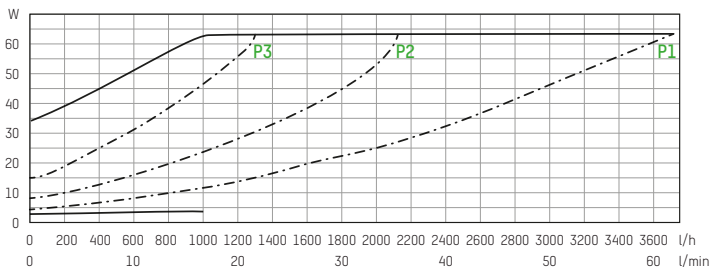

# TacoFlow3 / TacoFlow3 DUO

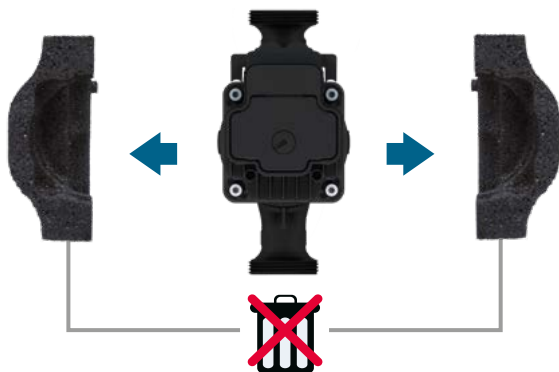
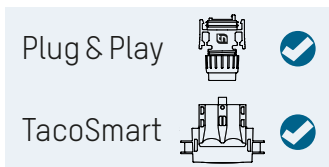
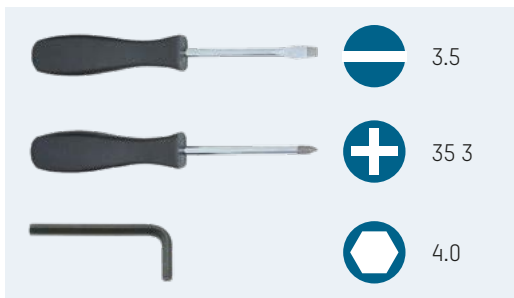



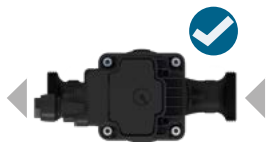
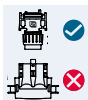

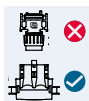

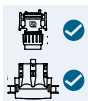

1



2

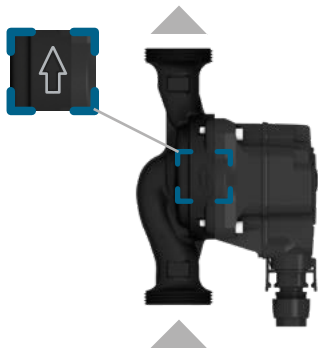

3

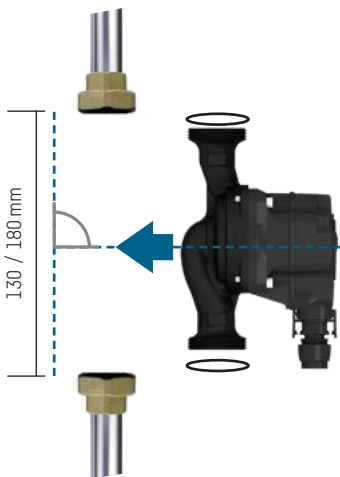

4

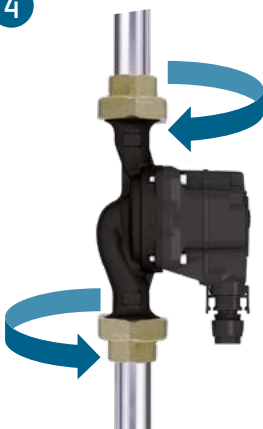

G1	PA 66 GF	Max. 50 Nm
G1	EN-GJL-200	Max. 85 Nm
G1½	EN-GJL-200	Max. 125 Nm
G2	EN-GJL-200	Max. 165 Nm

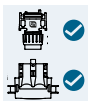

5



6

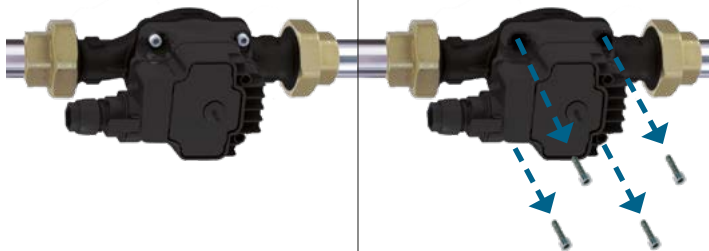

7

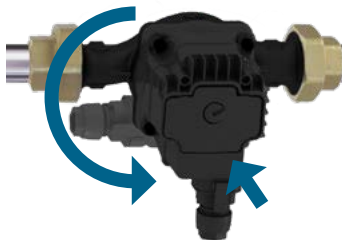

8

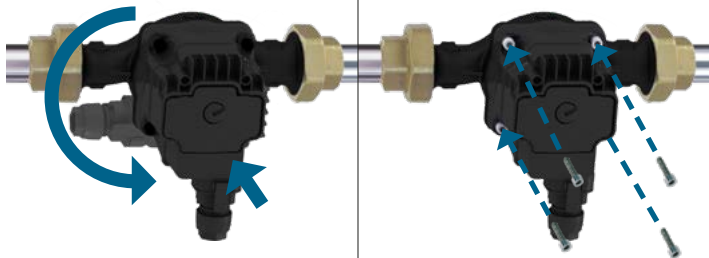

$3,3 \pm 0,5 \text{ Nm}$

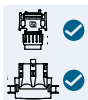

9



11

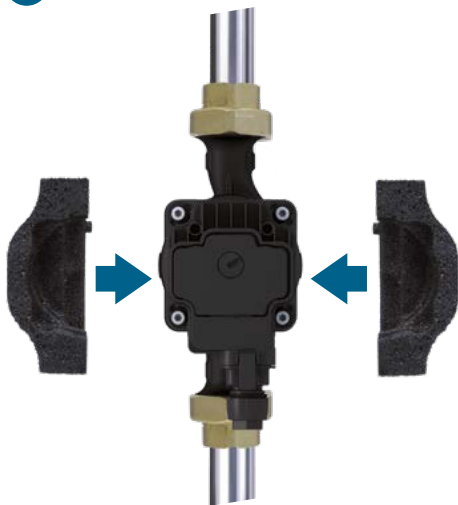

12



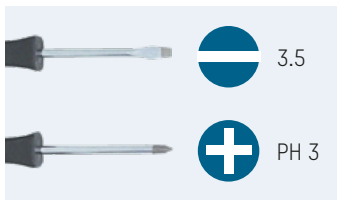

Plug & Play



→ page 22

**13** 1.1

TacoSmart



→ page 24

**13** 2.1

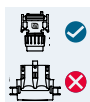

Plug & Play

**13** 1.1

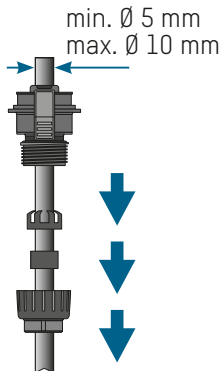

**13** 1.2

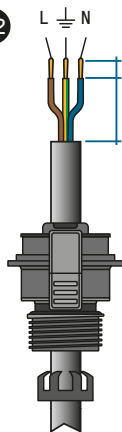

Load = Brown  
Ground = Yellow-green  
Neutral = Blue

Phase = Braun  
Erdung = Gelb/grün  
Neutral = Blau

Carico = Marrone  
Terra = Giallo verde  
Neutro = Blu

13 1.3

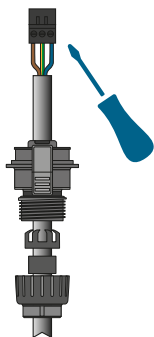

13 1.4

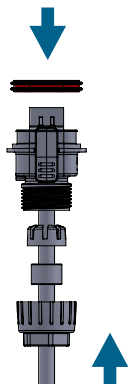

13 1.5

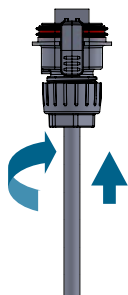

13 1.6

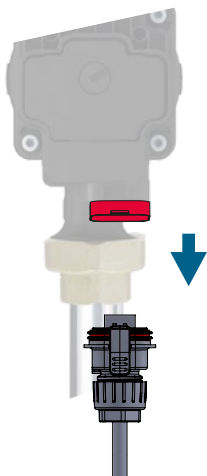

13 1.7

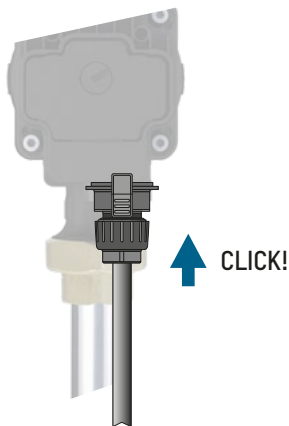

→ page 26

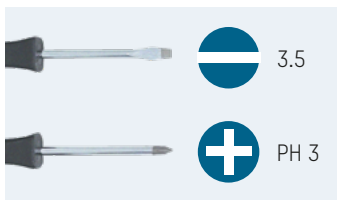

Plug & Play



→ page 22

13 1.1

TacoSmart



→ page 24

13 2.1

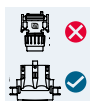

TacoSmart

13 2.1



13 2.2





# 13 2.3

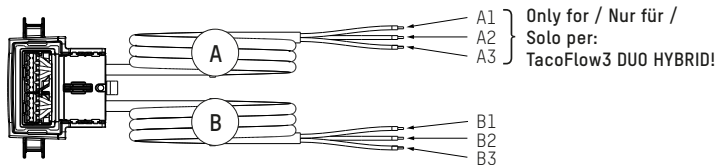

A	Signal cable	Signalkabel	Cavo di segnale
A1	Input (red)	Eingang (rot)	Ingresso (rosso)
A2	Com (brown)	Com (braun)	Com (marrone)
A3	Output (white)	Ausgang (weiss)	Uscita (bianco)
B	Power cable	Netzkabel	Cavo di alimentazione
B1	Line (brown)	Phase (braun)	Linea (marrone)
B2	Earth (yellow)	Erdung (gelb)	Terra (giallo)
B3	Neutral (blue)	Neutral (blau)	Neutro (blu)

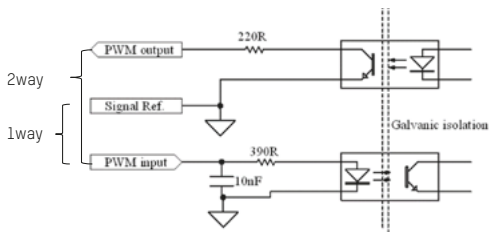

# 13 2.4



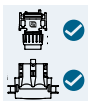

14



EU: 1x230V (+10%/-15%), 50Hz  
UK: 1x240 V (±10%), 50 Hz



min. 3 mm

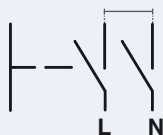

15

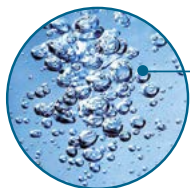

Further product  
documentation



taconova.com

16 1



16 2



16 3



# Troubleshooting

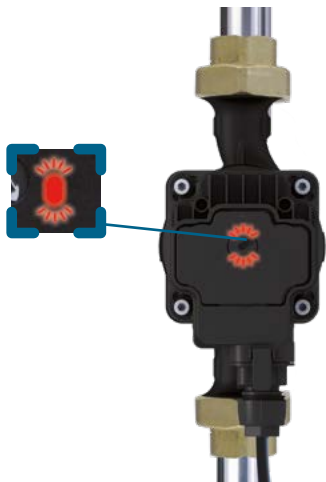

Further product  
documentation



[taconova.com](https://taconova.com)

EN	red LED	<b>WARNING!</b> The circulator is blocked, but is still power supplied. See Troubleshooting in the instruction manual on <a href="http://www.taconova.com">www.taconova.com</a>
DE	LED- Farbe rot	<b>VORSICHT!</b> Die Umwälzpumpe ist im Blockierungszustand, aber noch unter Spannung. Siehe Störungen: Ursachen und Lösungen in der Betriebsanleitung auf <a href="http://www.taconova.com">www.taconova.com</a>
IT	LED rosso	<b>ATTENZIONE!</b> Il circolatore è in stato di blocco ma è ancora sotto tensione. Vedi Problemi: cause e soluzioni nel manuale istruzioni su <a href="http://www.taconova.com">www.taconova.com</a>
CZ	Červené LED	<b>UPOZORNĚNÍ!</b> Oběhové čerpadlo je ve stavu zablokování, ale je stále pod napětím. Viz Problémy: příčiny a řešení v návodu na <a href="http://www.taconova.com">www.taconova.com</a>
FR	LED rouge	<b>ATTENTION!</b> Le circulateur est en état de blocage mais il est encore sous tension. Voir Problèmes : causes et solutions dans le manuel d'instructions est <a href="http://www.taconova.com">www.taconova.com</a>
PL	Dioda czerwona	<b>UWAGA!</b> Pompa cyrkulacyjna jest zablokowana, ale zasilanie jest nadal podłączone. Zob. Usterki: przyczyny i środki zaradcze w instrukcji obsługi is <a href="http://www.taconova.com">www.taconova.com</a>
BG	Червен светодиод	<b>ВНИМАНИЕ!</b> Циркулационната помпа е в спряло състояние, но още е под напрежение. Виж Проблеми - причини и начини за отстраняване в ръководството за употреба на <a href="http://www.taconova.com">www.taconova.com</a>
DA	Rød kontrol- lampe	<b>ADVARSEL!</b> Cirkulationspumpen er blokeret men er fortsat spændingsførende. Se Fejlfinding i instruktionsmanualen på <a href="http://www.taconova.com">www.taconova.com</a>
EL	LED Κόκκινο	<b>ΠΡΟΣΟΧΗ!</b> Ο κυκλοφορητής βρίσκεται σε κατάσταση εμπλοκής αλλά ακόμα είναι υπό τάση. Βλέπε Προβλήματα: αίτια και λύσεις, στο εγχειρίδιο οδηγιών στη <a href="http://www.taconova.com">www.taconova.com</a>



- ES** **LED Rojo** **¡ATENCIÓN!**  
La bomba de circulación se encuentra en estado de bloqueo pero aún bajo tensión. Ver Problemas, causas y soluciones en el manual de instrucciones en [www.taconova.com](http://www.taconova.com)
- ET** **Punane LED-tuli** **HOIATUS!**  
Tsirkulatsioonipump on blokeeritud, kuid toide on olemas. Vt kasutusjuhendist tõrkeotsingu jaotist [www.taconova.com](http://www.taconova.com)
- FI** **Punainen merk-kivalo** **VAROITUS!**  
Kiertoelin on lukkiutuneessa tilassa, mutta edelleen jännitteen alainen. Katso Ongelmat: syyt ja ratkaisut käyttöoppaassa on [www.taconova.com](http://www.taconova.com)
- HR** **Crveno led svjetlo** **PAŽNJA!**  
Cirkulacijska pumpa je u stanju blokade, ali i dalje pod naponom. Vidi Problemi: uzroci i rješenja u priručniku s uputama je [www.taconova.com](http://www.taconova.com)
- HU** **Piros LED** **FIGYELEM!**  
A keringető szivattyú le van tiltva, de még mindig feszültség alatt van. Lásd a Rendellenességek: okok és megoldások a kezelési kézikönyvben Ez [www.taconova.com](http://www.taconova.com)
- IS** **Rautt LED-ljós** **VIÐVÖRUN!**  
Hringrásardælan er stífluð en er enn að taka inn raforku. Sjá Bilanaleit í notendahandbókinni er [www.taconova.com](http://www.taconova.com)
- LT** **Raudo-nas šviesos diodas** **ĮSPĖJIMAS!**  
Energija tiekama, nors cirkulatorius užblokuotas. Žr. naudojimo instrukcijos skyrių „Trikčių šalinimas“ [www.taconova.com](http://www.taconova.com)
- LV** **Sarkanā LED** **BRĪDINĀJUMS!**  
Cirkulācijas sūkņis ir bloķēts, taču strāva vēl ir pieslēgta. Skatīt nodaļu "Kļūmju novēršana" lietošanas instrukcijā ir [www.taconova.com](http://www.taconova.com)
- NL** **Rode LED** **WAARSCHUWING!**  
De circulatiepomp is geblokkeerd maar staat nog onder spanning. Zie Problemen: oorzaken en oplossingen in de handleiding is [www.taconova.com](http://www.taconova.com)

- NO** **Rød LED** **ADVARSEL!**  
Sirkulasjonspumpen er låst, men fremdeles under spenning. Se Problemer: Årsaker og løsninger i bruksanvisningen er [www.taconova.com](http://www.taconova.com)
- PT** **LED vermelho** **ATENÇÃO!**  
O circulador está bloqueado, mas ainda se encontra alimentado. Consultar "Problemas: causas e soluções" no manual de instruções é [www.taconova.com](http://www.taconova.com)
- RU** **Красный световой индикатор** **ТЪВНИМАНИЕ!**  
Циркуляционный насос заблокирован, но продолжает находиться под напряжением. См. "Проблемы: причины и устранение" в инструкции [www.taconova.com](http://www.taconova.com)
- RO** **LED roșu** **ATENȚIE!**  
Aparatul este blocat, dar este încă sub tensiune. Depanare: cauze și soluții în manualul de instrucțiuni este [www.taconova.com](http://www.taconova.com)
- SV** **Röd lysdiod** **VARNING!**  
Cirkulationspumpen är blockerad men är fortfarande under spänning. Se Felsökning i bruksanvisningen är [www.taconova.com](http://www.taconova.com)
- SK** **Červená LED** **UPOZORNENIE!**  
Obehové čerpadlo je zablokované, ale je stále pod napätím. Vid' Problémy: príčiny a riešenia v návode je [www.taconova.com](http://www.taconova.com)
- SL** **Rdeča LED lučka** **POZOR!**  
Cirkulator je blokiran, a je še vedno pod napetostjo. Glejte Težave: vzroki in rešitve v priročniku z navodili je [www.taconova.com](http://www.taconova.com)

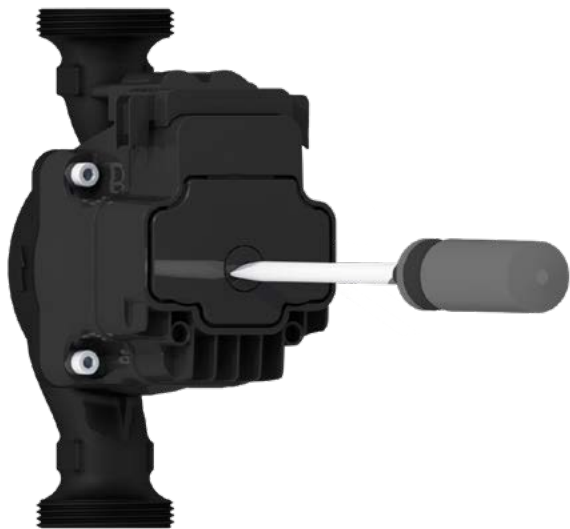



Mode / Modus / Modalità /  
Modalidad / Tryb / Režim /  
Λειτουργία







LED	 TacoAdapt™*	 E C (dp-c)
<b>EN</b> Description	Automatic adaptation to changes (Purple)	Constant differential pressure (Orange)
<b>DE</b> Beschreibung	Automatische Anpassung an Veränderungen (Violett)	Konstanter Differenzdruck (Orange)
<b>IT</b> Descrizione	Adattamento automatico alle modifiche (Porpora)	Differenza di pressione costante (Arancio)
<b>FR</b> Description	Adaptation automatique aux changements (Pourpre)	Différence de pression constante (Orange)
<b>ES</b> Descripción	Adaptación automática a los cambios (Púrpura)	Diferencia de presión constante (Naranja)
<b>CZ</b> Popis	Automatické přizpůsobení změnám (Purpurová)	Konstantní tlakový rozdíl (Oranžová)
<b>PL</b> Opis	Automatyczna adaptacja do zmian (purpurowy)	Stać różnica ciśnienia (pomarańczowy)
<b>EL</b> Περιγραφή	Αυτόματη προσαρμογή στις μεταβολές (Μωβ)	Σταθερή διαφορική πίεση (Πορτοκαλί)

\* TacoFlow3 (DUO) ADAPT / TacoFlow3 DUO HYBRID

LED	  P (dc-v)	  Min-Max	 PWM S / PWM H
<b>EN</b> Description	Proportional differential pressure (Green)	Fixed speed (Blue)	Externally controlled with solar or heating PWM signal (Yellow)
<b>DE</b> Beschreibung	Proportionaler Differenzdruck (Grün)	Festgelegte Drehzahl (Blau)	Extern durch Solar- oder Heizungs-PWM-Signal gesteuert (Gelb)
<b>IT</b> Descrizione	Differenza di pressione proporzionale (Verde)	Velocità fissa (Blu)	Controllato esternamente con segnale PWM solare o di riscaldamento (Giallo)
<b>FR</b> Description	Différence de pression proportionnelle (Verte)	Vitesse fixe (Bleue)	Contrôlé externe avec signal PWM solaire ou de chauffage (Jaune)
<b>ES</b> Descripción	Diferencia de presión proporcional (Verde)	Velocidad fija (Azul)	Controlado externamente con señal PWM solar o de calefacción (Amarillo)
<b>CZ</b> Popis	Proporcionální tlakový rozdíl (Zelená)	Stálá rychlost (Modrá)	Externě řízeno signálem PWM solárního nebo topného systému (Žlutá)
<b>PL</b> Opis	Proporcjonalna różnica ciśnienia (zielony)	Prędkość stała (niebieski)	Sterowane zewnętrznie sygnałem PWM z paneli słonecznych lub grzewczym (żółty)
<b>EN</b> Περιγραφή	Αναλογικά μεταβαλλόμενη διαφορική πίεση (Πράσινο)	Σταθερή ταχύτητα (Μπλε)	Εξωτερικός έλεγχος με ηλιακό ή θερμικό σήμα PWM (Κίτρινο)

\* TacoFlow3 DUO HYBRID

LED	 	
<b>EN</b> Description	Air detected Vent the system (White flashing slowly)	Alarm (Red)
<b>DE</b> Beschreibung	Lufterkennung Anlage entlüften (Langsames weisses Blinklicht)	Alarm (Rot)
<b>IT</b> Descrizione	Rilevazione di aria Procedere con la routine di sfianto (Bianco lampeggio lento)	Allarme (Rosso)
<b>FR</b> Description	Détection automatique de présence d'air Effectuer une purge (Blanche, clignote lentement)	Alarme (Rouge)
<b>ES</b> Descripción	Detección automática de aire en el sistema Proceder con la rutina de purga (Color blanco parpadeo lento)	Alarma (Rojo)
<b>CZ</b> Popis	Automatická detekce přítomnosti vzduchu v systému Proved'te odvětrání systému (Bílá pomalé blikání)	Alarm (Červená)
<b>PL</b> Opis	Automatyczne wykrywanie obecności powietrza w systemie Odpowietrzyć instalację (Biały miganie powolne)	Alarm (Czerwony)
<b>EL</b> Περιγραφή	Εντοπίστηκε αέρας. Εξαερώστε το σύστημα (το λαμπάκι έχει λευκό χρώμα και αναβοσβήνει αργά)	Συναγερμός (Κόκκινο)

## EN DECLARATION OF CONFORMITY

We TACO ITALIA S.r.L. / Taconova Production s.r.o. declare under our sole responsibility that the family of products TacoFlow to which this declaration relates are in conformity with the Council Directives on the approximations of the laws of the EC Member State relating to:

## DE Konformitätserklärung

Wir TACO ITALIA S.r.L. / Taconova Production s.r.o. erklären in alleiniger Verantwortung, dass die Produkte TacoFlow auf die sich diese Erklärung bezieht, mit den folgenden Richtlinien des Rates zur Angleichung der Rechtsvorschriften der EG-Mitgliedstaaten übereinstimmen:

## IT DICHIARAZIONE DI CONFORMITÀ

Noi TACO ITALIA S.r.L. / Taconova Production s.r.o. dichiariamo sotto la nostra esclusiva responsabilità che i prodotti TacoFlow ai quali questa dichiarazione si riferisce sono conformi alle Direttive del Consiglio concernente il ravvicinamento delle legislazioni degli Stati membri CE relative a:

## CZ PROHLÁŠENÍ O SHODĚ

My, firma TACO ITALIA S.r.L. / Taconova Production s.r.o., prohlašujeme na svou výhradní odpovědnost, že výrobky série TacoFlow, na které se toto prohlášení vztahuje, jsou ve shodě se směrnicemi Rady ke sblížení legislativ členských států ES, které se týkají:

## PL DEKLARACJA ZGODNOŚCI

My, TACO ITALIA S.r.L. / Taconova Production s.r.o., oświadczamy na naszą wyłączną odpowiedzialność, że produkty serii TacoFlow, do których odnosi się niniejsza deklaracja są zgodne z Dyrektywami Rady w sprawie zbliżenia ustawodawstw Państw Członkowskich dotyczących:

## FR Déclaration De Conformité

Nous TACO ITALIA S.r.L. / Taconova Production s.r.o. nous déclarons sous notre responsabilité exclusive que les produits TacoFlow auxquels cette déclaration se réfère sont conformes aux Directives du Conseil concernant le rapprochement des législations des états membres CE relatives à:

## BG ДЕКЛАРАЦИЯ ЗА СЪОТВЕТСТВИЕ

Ние, TACO ITALIA S.r.L. / Taconova Production s.r.o., декларираме на наша изключителна отговорност, че изделията от серия TacoFlow, за които се отнася настоящата декларация, са в съответствие с директивите на Съвета относно сближаването на законодателствата на държавите-членки на ЕО, отнасящи се до:

## DA OVERENSSTEMMELSEERKLÆRING

TACO ITALIA S.r.L. / Taconova Production s.r.o. erklærer på eget ansvar, at produkterne i TacoFlow serien, der er omfattet af denne erklæring, opfylder kravene i Rådets direktiver om indbyrdes tilnærmelse af medlemsstaternes lovgivning om:

## EL ΔΗΛΩΣΗ ΣΥΜΜΟΡΦΩΣΗΣ

Εμείς της TACO ITALIA S.r.L. / Taconova Production s.r.o. δηλώνουμε υπεύθυνα ότι τα προϊόντα της σειράς TacoFlow στα οποία αναφέρεται η παρούσα δήλωση είναι σύμφωνα με τις Οδηγίες του Συμβουλίου αναφορικά με τη σύγκλιση των νομοθεσιών των Κρατών μελών της ΕΚ σχετικά με:

## **ES** Declaración de Conformidad

Nosotros TACO ITALIA S.r.L. / Taconova Production s.r.o. declaramos bajo nuestra exclusiva responsabilidad que los productos TacoFlow los cuales esta declaración se refiere están conformes a las Directivas del Consejo concerniente el acercamiento de las legislaciones de los Estados miembros CE relativas a:

## **ET** VASTAVUSDEKLARATSIOON

TACO ITALIA S.r.L. / Taconova Production s.r.o. deklareerib oma ainuvastutusel, et tootepere TacoFlow, mille kohta see deklaratsioon on välja antud, vastab nõukogu direktiivile ELi liikmesriikide õigusaktide ühtlustamise kohta, mis puudutavad:

## **FI** VAATIMUSTENMUKAISUUSVAKUUTUS

TACO ITALIA S.r.L. / Taconova Production s.r.o. vakuuttaa omalla yksinomaisella vastuullaan, että tämän ilmoituksen kohteena olevat sarjan TacoFlow tuotteet täyttävät vaatimukset Neuvoston direktiiveissä, jotka koskevat EY:n jäsenmaiden lainsäädännön lähentämistä seuraavien aiheiden osalta:

## **HR** IZJAVA O SUKLADNOSTI

Naša tvrtka TACO ITALIA S.r.L. / Taconova Production s.r.o. daje izjavu isključivo pod vlastitom odgovornošću da su proizvodi serije TacoFlow, na koje se odnosi ova izjava, sukladni Direktivama Vijeća o usklađivanju zakonodavstva država članica EZ o:

## **HU** MEGFELELŐSÉGI NYILATKOZAT

Az TACO ITALIA S.r.L. / Taconova Production s.r.o. kijelenti a kizárólagos felelőssége alatt, hogy az TacoFlow terméksalád termékei, melyekre ez a nyilatkozat vonatkozik, megfelelnek az EK-tagállamok törvényeit egymáshoz közelítő alábbi tanácsi irányelveknek:

## **IS** SAMRÆMISYFIRLÝSING

Við, TACO ITALIA S.r.L. / Taconova Production s.r.o., lýsum því yfir og ábyrgjumst að fullu að vörulínan TacoFlow, sem þessi yfirlýsing á við um, samræmist tilskipunum ráðs Evrópubandalaganna um samræmingu laga aðildarríkja Evrópubandalaganna að því er varðar:

## **LT** ATITIKTIES DEKLARACIJA

Mes, „TACO ITALIA S.r.L. / Taconova Production s.r.o.“, prisiimdami visą atsakomybę skelbiame, kad „TacoFlow“ grupės gaminiai, kuriems taikoma ši deklaracija, atitinka Tarybos direktyvas dėl ES valstybių narių įstatymų, susijusių su toliau nurodytais aspektais, suderinimo reikalavimų:

## **LV** AATBILSTĪBAS DEKLARĀCIJA

Mēs, uzņēmuma TACO ITALIA S.r.L. / Taconova Production s.r.o. pārstāvji, kā vienīgie atbildīgie apliecinām, ka TacoFlow izstrādājumu sērija, uz kuru attiecas šī deklarācija, atbilst Eiropas Padomes direktīvu prasībām par tās dalībvalstu tiesību aktu tuvināšanu saistībā ar:

## **NL** Verklaring van overeenstemming

Wij, TACO ITALIA S.r.L. / Taconova Production s.r.o., verklaren onder eigen verantwoordelijkheid, dat de producten van de TacoFlow serie waar deze verklaring betrekking op heeft, overeenstemmen met de Richtlijnen van de Raad betreffende de onderlinge aanpassing van de wettelijke voorschriften der lidstaten inzake:

## **NO** SAMSVARSERKLÆRING

TACO ITALIA S.r.L. / Taconova Production s.r.o. erklærer på eget ansvar at produktene i serien TacoFlow, som denne erklæringen refererer til, er i samsvar med Rådsdirektivene om tilnærming av medlemsstatenes lovgivning vedrørende:

## **PT** DECLARAÇÃO DE CONFORMIDADE

Nós, TACO ITALIA S.r.L. / Taconova Production s.r.o., declaramos sob nossa exclusiva responsabilidade que os produtos da série TacoFlow aos quais se refere esta declaração estão em conformidade com as Diretivas do Conselho que harmonizam as legislações dos Estados-Membros CE em matéria de:

## **RU** ДЕКЛАРАЦИЯ О СООТВЕТСТВИИ

Мы, компания TACO ITALIA S.r.L. / Taconova Production s.r.o., со всей ответственностью заявляем, что продукция серии TacoFlow, в отношении которой предоставляется настоящая декларация, соответствует требованиям Директивы Совета по вопросам сближения национальных законодательств стран-членов ЕС:

## **RO** DECLARAȚIE DE CONFORMITATE

Noi, TACO ITALIA S.r.L. / Taconova Production s.r.o., declarăm pe propria răspundere că produsele din seria TacoFlow, la care face referire această declarație, sunt conforme cu Directiva Consiliului cu privire la armonizarea legislațiilor statelor membre ale CE cu privire la:

## **SV** FÖRSÄKRAN OM ÖVERENSSTÄMMELSE

Vi, TACO ITALIA S.r.L. / Taconova Production s.r.o., försäkrar under eget ansvar att produktfamiljen TacoFlow som omfattas av denna försäkran uppfyller rådets direktiv om tillnärmning av medlemsstaternas lagar rörande:

## **SK** VYHLÁSENIE oZHoDe

My, TACO ITALIA S.r.L. / Taconova Production s.r.o., vyhlasujeme na vlastnú zodpovednosť, že produkty TacoFlow, ktorých sa toto vyhlásenie týka, sú v zhode s týmito smernicami Rady pre harmonizáciu právnych predpisov členského štátu ES:

## **SL** IZJAVA O SKLADNOSTI

Mi, TACO ITALIA S.r.L. / Taconova Production s.r.o. z izključno lastno odgovornostjo izjavljamo, da so izdelki iz serije TacoFlow, na katere se nanaša ta izjava, skladni z direktivami Evropskega sveta v zvezi s približevanjem zakonodaje Držav članic EU v zvezi z:

## **TR** UYUMLULUK BEYANI

Biz, TACO ITALIA S.r.L. / Taconova Production s.r.o. olarak yalnızca kendi sorumluluğumuz altında bu beyanın ilgili olduğu TacoFlow ürün ailesinin AT Üye Devletlerin şunlarla ilgili yasalarının yakınlaştırılmasına yönelik Konsey Direktiflerine uyumlu olduğunu beyan ederiz:

**EMCD Directive (2014/30/EU)**

Standard used: EN 61000-3-2:2014, EN 61000-3-3:2013, EN 55014-1:2006, EN 55014-2:2015 (amendments included)

**LVD Directive (2014/35/EU)**

Standard used: EN 62233:2008, EN 60335-1:2012, EN 60335-2-51:2003 (including amendments) EN 60335-2-40:2014-01; EN 60335-2-40:2003 cl. 22,116 and cl. 22.117

**Ecodesign Directive (2009/125/EC and 2012/27/EU)**

Commission Regulation n. 641/2009 and n. 622/2012.

Applies only to circulators marked with the energy efficiency index EEL.

See the pump nameplate.

Standards used: EN 16297-1:2012 and EN 16297-2:2012

**RoHS II Directive (2011/65/EU)**

Velešín, 01/04/2024



**Martin Marek**  
General Manager

**Taconova Production SRO**

Nová 627 | 382 32 Velešín | Czech Republic

Person authorized to compile technical file and empowered to sign the EC declaration of Conformity.

This EC declaration of conformity is only valid when published and distributed as part of the installation and operating instructions.



# taconova

comfort solutions

Taconova reserves the right to make changes without prior notice.

## **Taconova Group AG**

Neunbrunnenstrasse 40 | CH-8050 Zürich

T +41 44 735 55 55 | F +41 44 735 55 02

info@taconova.com

## **Taconova GmbH**

Rudolf-Diesel-Straße 8 | DE-78224 Singen

T +49 7731 98 28 80 | F +49 7731 98 28 88

deutschland@taconova.com

## **Taconova Production s.r.o.**

Nová 627 | CZ-38232 Velešín

T +420 380 30 14 12

cesko-slovensko@taconova.com

## **Taconova UK Limited**

Technology Centre | Advanced Manufacturing Park

Brunel Way | Rotherham | S60 5WG | United Kingdom

T +44 (0) 114 231 3700

adminuk@taconova.com

## **Taconova Polska Sp z o.o**

ul. Wrocławska 21/8 | PL-61-837 Poznań

Tel: +48 61 227 84 21

polska@taconova.com

## **Taco Italia S.r.L.**

Via Galileo Galilei, 89/91 | IT-36066 Sandrigo (VI)

T +39 0444 666800 | F +39 0444 666801

info@tacoitalia.com | tacoitalia.com



taconova.com

**Taco**  
Family of Companies